



Type 2+3 Surge Arrester

www.britecelectric.com

BR-40DP

Type 2+3 Surge Arrester

BR-40DP 4P
BR-40DP 3+1

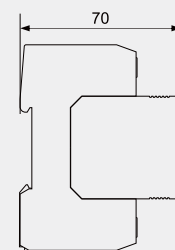
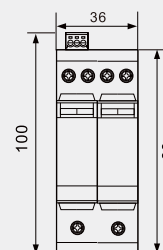
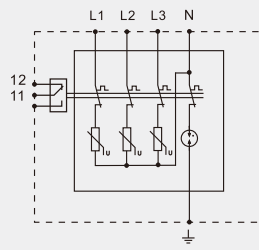
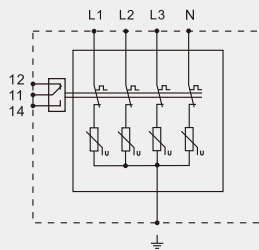
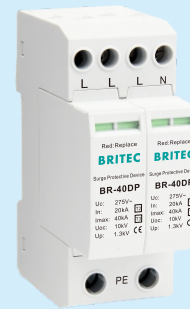

Type 2+Type 3 surge arrester is installed between LPZ1 and LPZ2, it can provide type 3 protection for equipments which installed within 5 meters from these devices.

	BR-275 40DP 4	BR-320 40DP 4	BR-275 40DP 3+1	BR-320 40DP 3+1	
SPD classification according to EN61643-11	Type 2+Type 3	Type 2+Type 3	Type 2+Type 3	Type 2+Type 3	
SPD classification according to IEC61643-11	Class II+Class III	Class II+Class III	Class II+Class III	Class II+Class III	
Max. continuous operating a.c. voltage	Uc	275V	320V	275V	320V
Nominal discharge current (8/20μs)	In	20kA	20kA	20kA	20kA
Max. discharge current (8/20μs)	I _{max}	40kA	40kA	40kA	40kA
Voltage protection level	Up	≤1.3kV	≤1.5kV	≤1.3kV/1.5kV	≤1.5kV/1.5kV
Voltage protection level 5kA	Up	≤1.0kV	≤1.2kV	≤1.0kV/1.5kV	≤1.2kV/1.5kV
Combined impulse	Uoc	10kV	10kV	10kV	10kV
Max. backup fuse		100A gG	100A gG	100A gG	100A gG
Short-circuit withstand capacity	I _{SCCR}	25kA	25kA	25kA	25kA
Temporary overvoltage TOV-withstand	U _T	335V/5sec.	350V/5sec.	335V/5sec.	350V/5sec.
Temporary overvoltage TOV-safe failure	U _T	440V/120min.	550V/120min.	440V/120min.	550V/120min.
Leakage current	I _{PE}	<0.1mA	<0.1mA	<0.1mA	<0.1mA
Response time	t _A	≤25ns	≤25ns	≤25ns	≤25ns
Operating temperature range	T _u	-40°C-80°C	-40°C-80°C	-40°C-80°C	-40°C-80°C
Operating state/fault indication		green/red	green/red	green/red	green/red
Cross-section area (Min.)		2.5 mm ²	2.5 mm ²	2.5 mm ²	2.5 mm ²
Cross-section area (Max.)		16 mm ²	16 mm ²	16 mm ²	16 mm ²
For mounting on	35mm Din rail				
Enclosure material	Thermoplastic UL94-V0				
Degree of protection	IP20	IP20	IP20	IP20	
Order Code	B18220	B17250	B18243	B17254	
Order Code (With remote signaling)	B18221	B17251	B18244	B17255	

BR-40DP

Type 2+3 Surge Arrester

BR-40DP 2P
BR-40DP 1+1

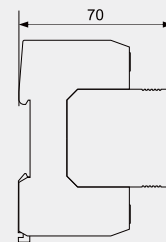
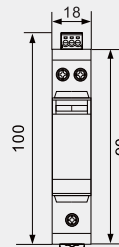
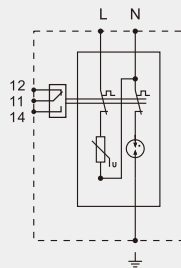
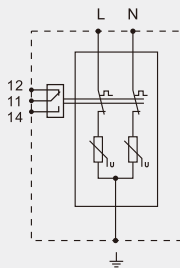

Type 2+Type 3 surge arrester is installed between LPZ1 and LPZ2, it can provide type 3 protection for equipments which installed within 5 meters from these devices.

	BR-275 40DP 2	BR-320 40DP 2	BR-275 40DP 1+1	BR-320 40DP 1+1
SPD classification according to EN61643-11	Type 2+Type 3	Type 2+Type 3	Type 2+Type 3	Type 2+Type 3
SPD classification according to IEC61643-11	Class II+Class III	Class II+Class III	Class II+Class III	Class II+Class III
Max. continuous operating a.c. voltage	Uc	275V	320V	275V
Nominal discharge current (8/20μs)	In	20kA	20kA	20kA
Max. discharge current (8/20μs)	I _{max}	40kA	40kA	40kA
Voltage protection level	Up	≤1.3kV	≤1.5kV	≤1.3kV/1.5kV
Voltage protection level 5kA	Up	≤1.0kV	≤1.2kV	≤1.0kV/1.5kV
Combined impulse	Uoc	10kV	10kV	10kV
Max. backup fuse		100A gG	100A gG	100A gG
Short-circuit withstand capacity	I _{SCCR}	25kA	25kA	25kA
Temporary overvoltage TOV-withstand	U _T	335V/5sec.	350V/5sec.	335V/5sec.
Temporary overvoltage TOV-safe failure	U _T	440V/120min.	550V/120min.	440V/120min.
Leakage current	I _{PE}	<0.1mA	<0.1mA	<0.1mA
Response time	t _A	≤25ns	≤25ns	≤25ns
Operating temperature range	T _u	-40°C-80°C	-40°C-80°C	-40°C-80°C
Operating state/fault indication		green/red	green/red	green/red
Cross-section area (Min.)		2.5 mm ²	2.5 mm ²	2.5 mm ²
Cross-section area (Max.)		16 mm ²	16 mm ²	16 mm ²
For mounting on	35mm Din rail			
Enclosure material	Thermoplastic UL94-V0			
Degree of protection	IP20	IP20	IP20	IP20
Order Code	B18241	B17252	B18245	B17256
Order Code (With remote signaling)	B18242	B17253	B18246	B17257



Type 3 Surge Arrester

BR-20DP

Type 3 Surge Arrester

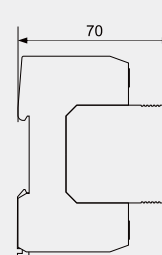
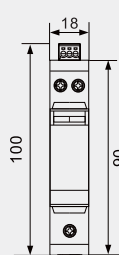
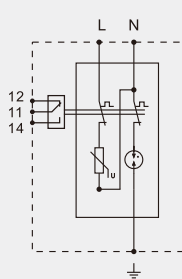
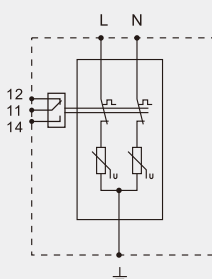

■ Type 3 surge arrester is installed between LPZ2 and LPZ3, it can provide protection for equipments.

	BR30-20DP	BR75-20DP	BR150-20DP	BR275-20DP
SPD classification according to EN61643-11	Type 3	Type 3	Type 3	Type 3
SPD classification according to IEC61643-11	Class III	Class III	Class III	Class III
Nominal a.c. voltage	Un	24V	60V	120V
Max. continuous operating a.c. voltage	Uc	30V	75V	150V
Max. continuous operating d.c. voltage	Uc	38V	100V	190V
Nominal discharge current (8/20μs)	In	10kA	10kA	10kA
Combined impulse	Uoc	10kV	10kV	10kV
Voltage protection level	Up	≤300V	≤600V	≤800V
Short-circuit withstand capacity	IscCR	25kA	25kA	25kA
Temporary overvoltage TOV-withstand	UT	36V/5sec.	90V/5sec.	175V/5sec.
Temporary overvoltage TOV-safe failure	UT	47V/120min.	119V/120min.	250V/120min.
Leakage current	IPe	<0.1mA	<0.1mA	<0.1mA
Response time	tA	≤25ns	≤25ns	≤25ns
Operating temperature range	Tu	-40°C-80°C	-40°C-80°C	-40°C-80°C
Operating state/fault indication		green/red	green/red	green/red
Cross-section area (Min.)		2.5 mm ²	2.5 mm ²	2.5 mm ²
Cross-section area (Max.)		16 mm ²	16 mm ²	16 mm ²
For mounting on	35mm Din rail			
Enclosure material	Thermoplastic UL94-V0			
Degree of protection	IP20	IP20	IP20	IP20
Order Code	2P	B18345	B18343	B18341
Order Code (with remote signal)	2P	B18346	B18344	B18342
Order Code	1+1	B18353	B18351	B18349
Order Code (with remote signal)	1+1	B18354	B18352	B18350

BR-230

Type 3 Surge Arrester

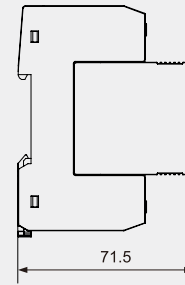
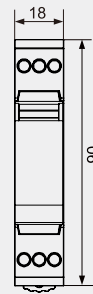
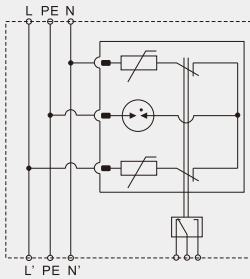

■ Type 3 surge arrester is installed between LPZ2 and LPZ3, it can provide protection for equipments.

		BR230-30	BR230-75	BR230-150	BR230-275
SPD classification according to EN61643-11		Type 3	Type 3	Type 3	Type 3
SPD classification according to IEC61643-11		Class III	Class III	Class III	Class III
Nominal a.c. voltage	Un	24V	60V	120V	230V
Max. continuous operating a.c. voltage	Uc	30V	75V	150V	275V
Max. continuous operating d.c. voltage	Uc	38V	100V	190V	300V
Nominal discharge current (8/20μs)	In	5kA	5kA	5kA	5kA
Combined impulse	Uoc	10kV	10kV	10kV	10kV
Nominal load current a.c.	IL	25A	25A	25A	25A
Voltage protection level	Up	≤630V	≤730V	≤800V	≤1500V
Max. over current protection		25A gG	25A gG	25A gG	25A gG
Short-circuit withstand capacity	I _{SCCR}	10kA	10kA	10kA	10kA
Leakage current	I _{PE}	<0.1mA	<0.1mA	<0.1mA	<0.1mA
Response time (L-N/LN-PE)	t _A	≤25ns/100ns	≤25ns/100ns	≤25ns/100ns	≤25ns/100ns
Operating temperature range	Tu	-40°C-80°C	-40°C-80°C	-40°C-80°C	-40°C-80°C
Operating state/fault indication		green/red	green/red	green/red	green/red
Cross-section area (Min.)		1 mm ²			
Cross-section area (Max.)		4.0mm ² solid/2.5mm ² flexible			
For mounting on		35mm Din rail			
Enclosure material		Thermoplastic UL94-V0			
Degree of protection		IP20	IP20	IP20	IP20
Order Code		B18237	B18235	B18359	B18231
Order Code (with remote signal)		B18238	B18236	B18234	B18232

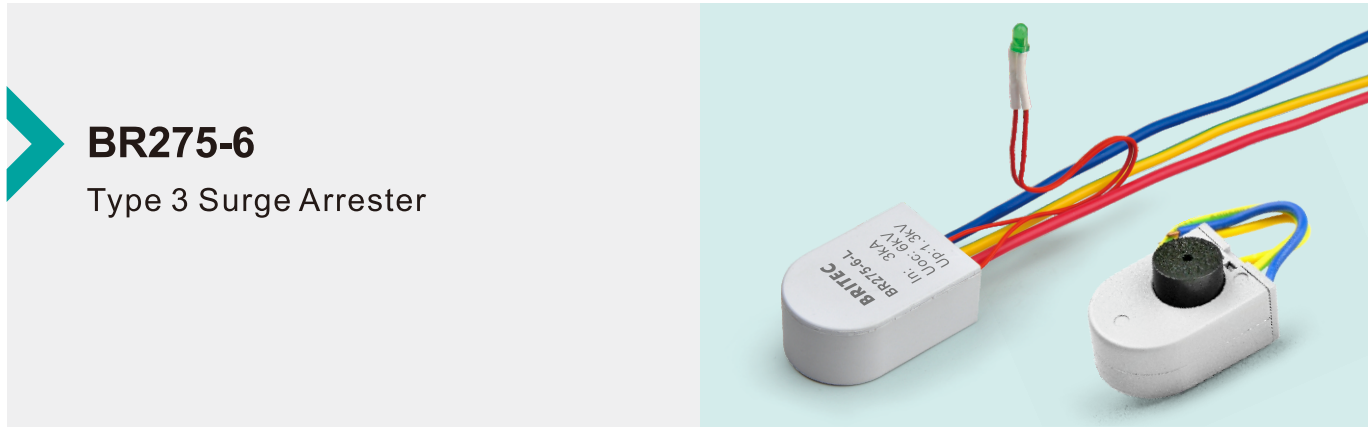

BR275-6 Type 3 Surge Arrester

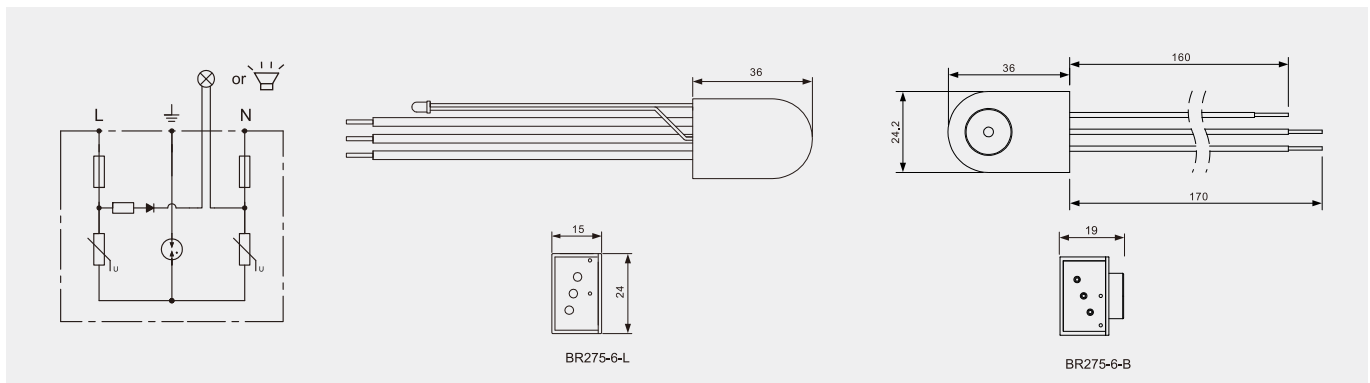

■ Type 3 surge arrester is installed between LPZ2 and LPZ3, it can provide protection for equipments.

	BR275-6-L	BR275-6-B
SPD classification according to EN61643-11	Type 3	Type 3
SPD classification according to IEC61643-11	Class III	Class III
Nominal a.c. voltage	Un	230V
Max. continuous operating a.c. voltage	Uc	275V
Max. continuous operating d.c. voltage	Uc	300V
Nominal discharge current (8/20μs)	In	3kA
Combined impulse	Uoc	6kV
Voltage protection level	Up	≤ 1.3kV
Response time	tA	≤ 25ns
Operating temperature range	Tu	-40°C-80°C
Operating state/fault indication	LED	BEEP
For mounting on	35mm Din rail	35mm Din rail
Enclosure material	Thermoplastic UL94-V0	Thermoplastic UL94-V0
Degree of protection	IP20	IP20
Order Code	B8355	B8357

BRLED-06SC

Surge Arresters for LED

BRLED-06SC-VG
BRLED-06SC-NG
BRLED-06SC-TT

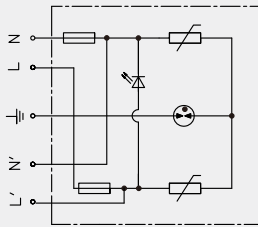

BRLED-06SC-VG

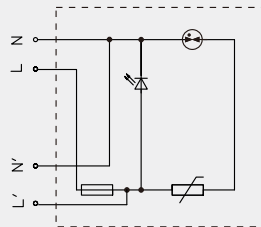

BRLED-06SC-NG

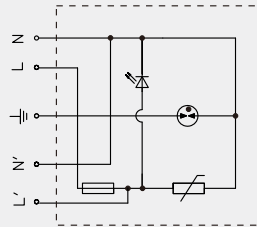

BRLED-06SC-TT

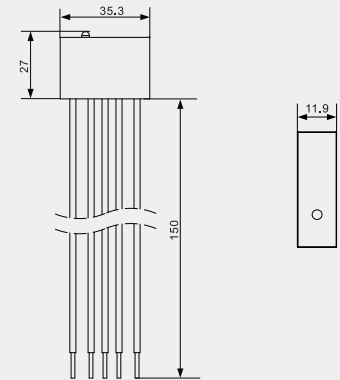

		BRLED-06SC-VG	BRLED-06SC-NG	BRLED-06SC-TT
SPD classification according to EN61643-11		Type 2+Type 3	Type 2+Type 3	Type 2+Type 3
SPD classification according to IEC61643-11		Class II+Class III	Class II+Class III	Class II+Class III
Nominal a.c. voltage	Un	230V	230V	230V
Max. continuous operating a.c. voltage	Uc	275V	275V	275V
Frequency		50-60Hz	50-60Hz	50-60Hz
Nominal discharge current (8/20μs)	In	3kA	3kA	3kA
Max. discharge current (8/20μs)	Imax	6kA	6kA	6kA
Max. Load	IL	10A	10A	10A
Combined impulse	Uoc	6kV	6kV	6kV
Voltage protection level	Up	≤1.3kV	≤1.3kV	≤1.3kV
Response time	tA	≤100ns	≤100ns	≤100ns
Operating temperature range	Tu	-40°C-80°C	-40°C-80°C	-40°C-80°C
Operating state		Green light on: OK, Green light off: Replace		
Enclosure material		Thermoplastic UL94-V0		
Degree of protection		IP 65		
Order Code		B6024	B6025	B6026

BRLED-06P

Surge Arresters for LED

BRLED-06P-VG
BRLED-06P-NG
BRLED-06P-TT

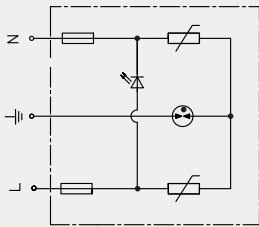

BRLED-06P-VG

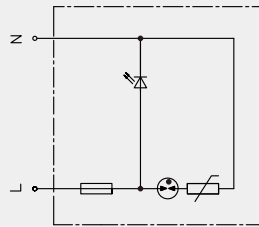

BRLED-06P-NG

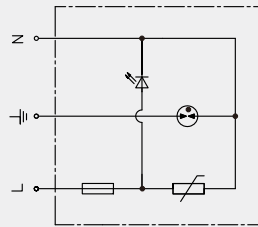

BRLED-06P-TT

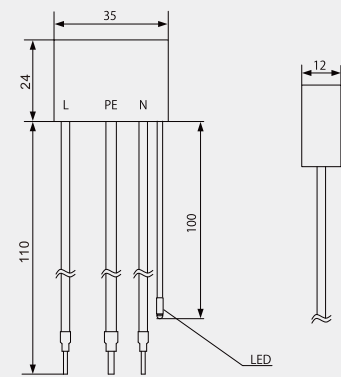

		BRLED-06P-VG	BRLED-06P-NG	BRLED-06P-TT
SPD classification according to EN61643-11		Type 2+Type 3	Type 2+Type 3	Type 2+Type 3
SPD classification according to IEC61643-11		Class II+Class III	Class II+Class III	Class II+Class III
Nominal a.c. voltage	Un	230V	230V	230V
Max. continuous operating a.c. voltage	Uc	275V	275V	275V
Frequency		50-60Hz	50-60Hz	50-60Hz
Nominal discharge current (8/20μs)	In	3kA	3kA	3kA
Max. discharge current (8/20μs)	Imax	6kA	6kA	6kA
Combined impulse	Uoc	6kV	6kV	6kV
Voltage protection level	Up	≤1.3kV	≤1.3kV	≤1.3kV
Response time	tA	≤100ns	≤100ns	≤100ns
Operating temperature range	Tu	-40°C-80°C	-40°C-80°C	-40°C-80°C
Operating state		Green light on: OK, Green light off: Replace		
Enclosure material		Thermoplastic UL94-V0		
Degree of protection		IP 65		
Order Code		B6021	B6022	B6023

BRLED-10SC

Surge Arresters for LED

BRLED-10SC-VG
BRLED-10SC-NG
BRLED-10SC-TT

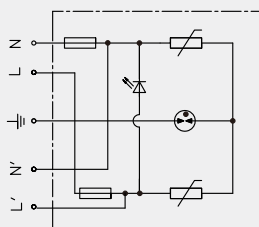
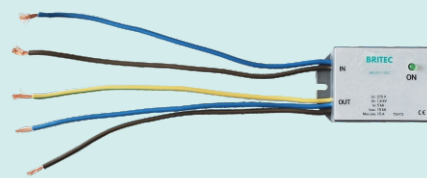

BRLED-10SC-VG

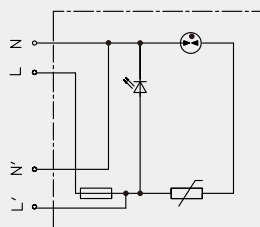

BRLED-10SC-NG

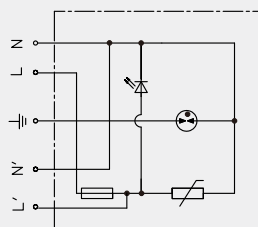

BRLED-10SC-TT

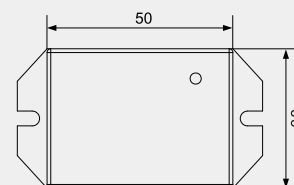
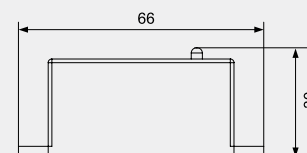

		BRLED-10SC-VG	BRLED-10SC-NG	BRLED-10SC-TT
SPD classification according to EN61643-11		Type 2+Type 3	Type 2+Type 3	Type 2+Type 3
SPD classification according to IEC61643-11		Class II+Class III	Class II+Class III	Class II+Class III
Nominal a.c. voltage	Un	230V	230V	230V
Max. continuous operating a.c. voltage	Uc	275V	275V	275V
Frequency		50-60Hz	50-60Hz	50-60Hz
Nominal discharge current (8/20μs)	In	5kA	5kA	5kA
Max. discharge current (8/20μs)	Imax	10kA	10kA	10kA
Max. Load	IL	15A	15A	15A
Combined impulse	Uoc	10kV	10kV	10kV
Voltage protection level	Up	≤1.3kV	≤1.3kV	≤1.3kV
Response time	tA	≤100ns	≤100ns	≤100ns
Operating temperature range	Tu	-40°C-80°C	-40°C-80°C	-40°C-80°C
Operating state		Green light on: OK, Green light off: Replace		
Enclosure material		Thermoplastic UL94-V0		
Degree of protection		IP 65		
Order Code		B6029	B6030	B6031

BRLED-10P

Surge Arresters for LED

BRLED-10P-VG
BRLED-10P-NG
BRLED-10P-TT

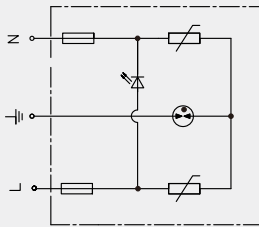
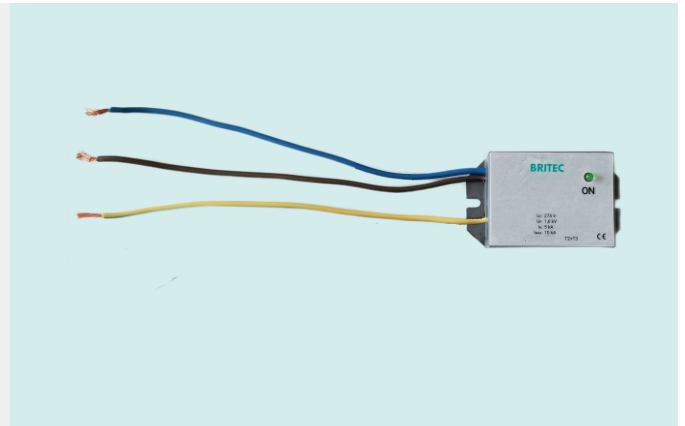

BRLED-10P-VG

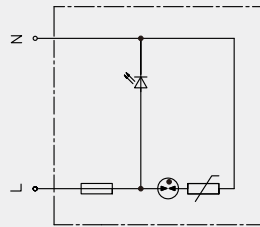

BRLED-10P-NG

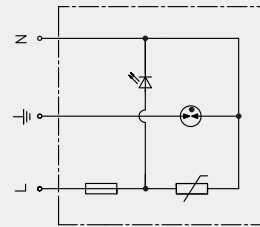

BRLED-10P-TT

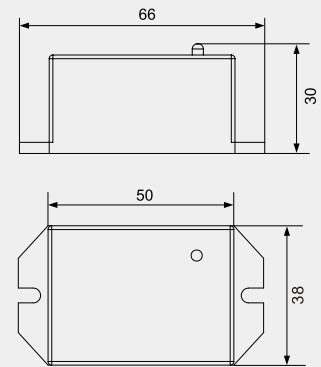

		BRLED-10P-VG	BRLED-10P-NG	BRLED-10P-TT
SPD classification according to EN61643-11		Type 2+Type 3	Type 2+Type 3	Type 2+Type 3
SPD classification according to IEC61643-11		Class II+Class III	Class II+Class III	Class II+Class III
Nominal a.c. voltage	Un	230V	230V	230V
Max. continuous operating a.c. voltage	Uc	275V	275V	275V
Frequency		50-60Hz	50-60Hz	50-60Hz
Nominal discharge current (8/20μs)	In	5kA	5kA	5kA
Max. discharge current (8/20μs)	Imax	10kA	10kA	10kA
Combined impulse	Uoc	10kV	10kV	10kV
Voltage protection level	Up	≤1.3kV	≤1.3kV	≤1.3kV
Response time	tA	≤100ns	≤100ns	≤100ns
Operating temperature range	Tu	-40°C-80°C	-40°C-80°C	-40°C-80°C
Operating state		Green light on: OK, Green light off: Replace		
Enclosure material		Thermoplastic UL94-V0		
Degree of protection		IP 65		
Order Code		B6032	B6033	B6034



BRRL-SC Surge Arresters for LED

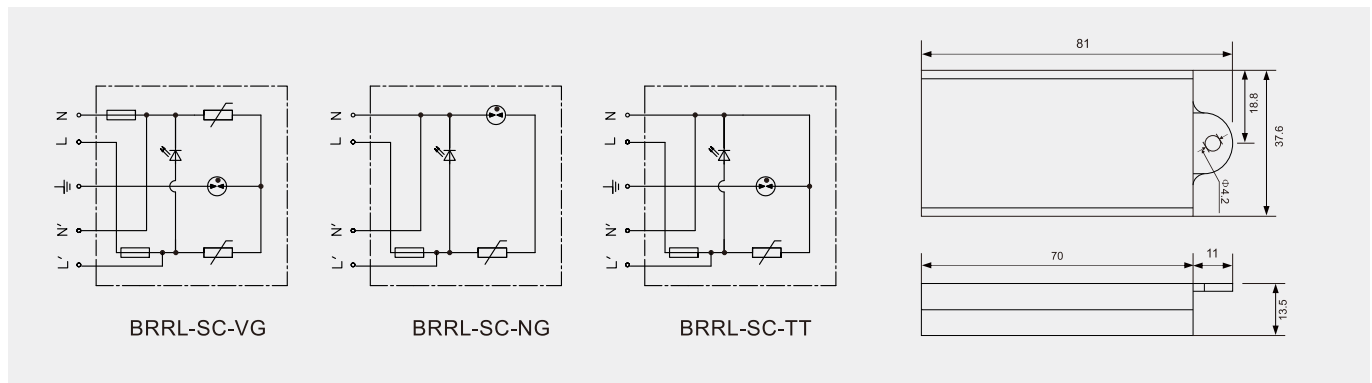

		BRRL-SC-VG	BRRL-SC-NG	BRRL-SC-TT
SPD classification according to EN61643-11		Type 2+Type 3	Type 2+Type 3	Type 2+Type 3
SPD classification according to IEC61643-11		Class II+Class III	Class II+Class III	Class II+Class III
Nominal a.c. voltage	Un	230V	230V	230V
Max. continuous operating a.c. voltage	Uc	275V	275V	275V
Frequency		50-60Hz	50-60Hz	50-60Hz
Nominal discharge current (8/20μs)	In	5kA	5kA	5kA
Max. discharge current (8/20μs)	Imax	20kA	20kA	20kA
Max. Load	IL	15A	15A	15A
Combined impulse	Uoc	10kV	10kV	10kV
Voltage protection level	Up	≤1.3kV	≤1.3kV	≤1.3kV
Response time	tA	≤100ns	≤100ns	≤100ns
Operating temperature range	Tu	-40°C-80°C	-40°C-80°C	-40°C-80°C
Operating state		Green light on: OK, Green light off: Replace		
Enclosure material		Thermoplastic UL94-V0		
Degree of protection		IP 65		
Order Code		B6014	B6015	B6016



BRRL-P

Surge Arresters for LED

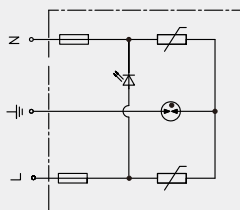

BRRL-P-VG

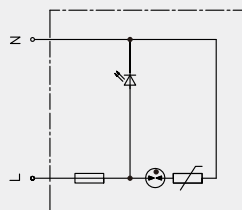

BRRL-P-NG

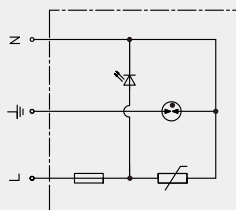

BRRL-P-TT

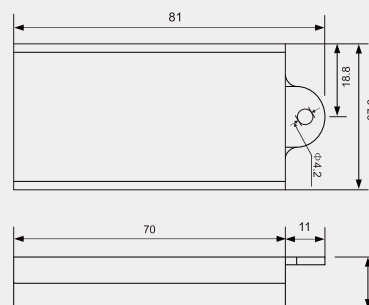

		BRRL-P-VG	BRRL-P-NG	BRRL-P-TT
SPD classification according to EN61643-11		Type 2+Type 3	Type 2+Type 3	Type 2+Type 3
SPD classification according to IEC61643-11		Class II+Class III	Class II+Class III	Class II+Class III
Nominal a.c. voltage	Un	230V	230V	230V
Max. continuous operating a.c. voltage	Uc	275V	275V	275V
Frequency		50-60Hz	50-60Hz	50-60Hz
Nominal discharge current (8/20μs)	In	5kA	5kA	5kA
Max. discharge current (8/20μs)	Imax	20kA	20kA	20kA
Combined impulse	Uoc	10kV	10kV	10kV
Voltage protection level	Up	≤1.3kV	≤1.3kV	≤1.3kV
Response time	tA	≤100ns	≤100ns	≤100ns
Operating temperature range	Tu	-40°C-80°C	-40°C-80°C	-40°C-80°C
Operating state		Green light on: OK, Green light off: Replace		
Enclosure material		Thermoplastic UL94-V0		
Degree of protection		IP 65		
Order Code		B6011	B6012	B6013

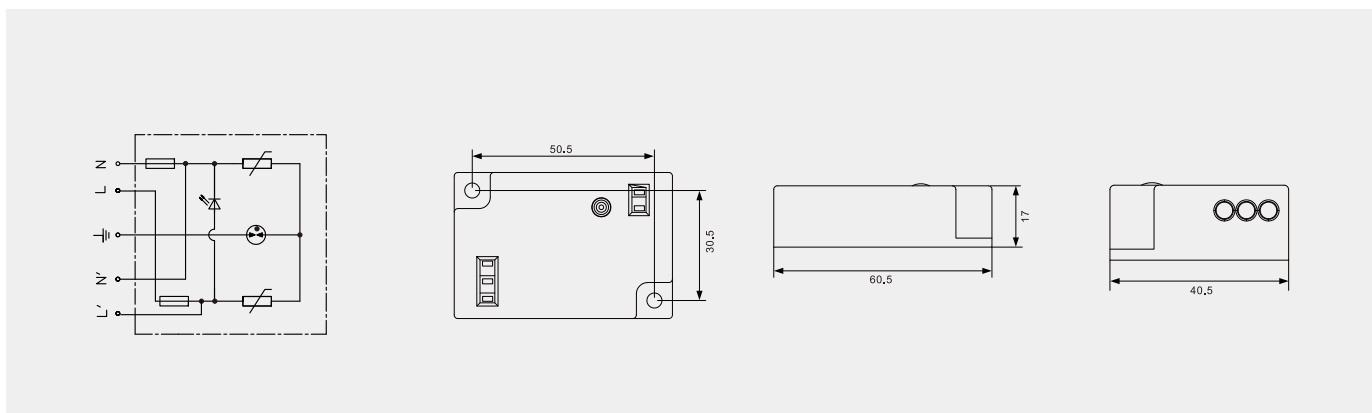
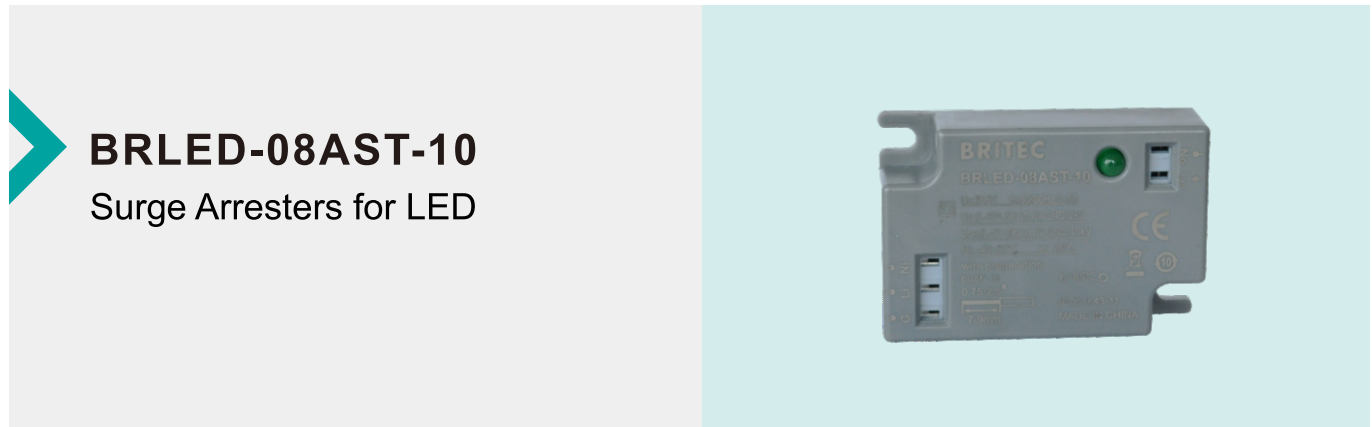

		BRLED-08AST-10
SPD classification according to EN61643-11		Type 2+Type 3
SPD classification according to IEC61643-11		Class II+Class III
Nominal a.c. voltage	Un	230V
Max. continuous operating a.c. voltage	Uc	305V
Frequency		50-60Hz
Nominal discharge current (8/20μs)	In	5kA
Max. discharge current (8/20μs)	Imax	10kA
Max. Load	IL	10A
Combined impulse	Uoc	10kV
Voltage protection level	Up	≤1.5kV
Response time	tA	≤100ns
Operating temperature range	Tu	-40°C-80°C
Operating state		Green light on:OK/ Light off: Replace
Enclosure material		Thermoplastic UL94-V0
Degree of protection		IP 65
Order Code		B6027



BRLED-08ASC-10 Surge Arresters for LED

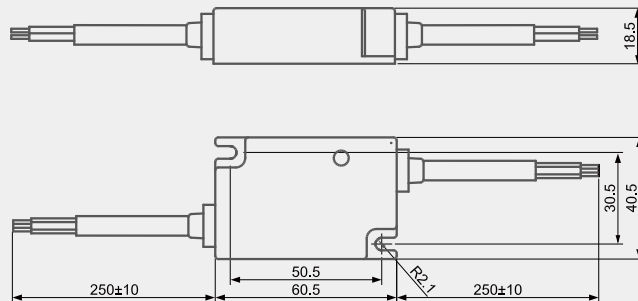
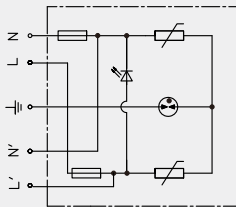

		BRLED-08ASC-10
SPD classification according to EN61643-11		Type 2+Type 3
SPD classification according to IEC61643-11		Class II+Class III
Nominal a.c. voltage	Un	230V
Max. continuous operating a.c. voltage	Uc	305V
Frequency		50-60Hz
Nominal discharge current (8/20µs)	In	5kA
Max. discharge current (8/20µs)	Imax	10kA
Max. Load	IL	10A
Combined impulse	Uoc	10kV
Voltage protection level	Up	≤1.5kV
Response time	tA	≤100ns
Operating temperature range	Tu	-40°C-80°C
Operating state		Green light on:OK/ Light off: Replace
Enclosure material		Thermoplastic UL94-V0
Degree of protection		IP 65
Order Code		B6028

BRLED-DIN Surge Arresters for LED

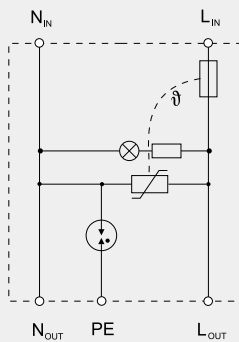

BRLED-DIN

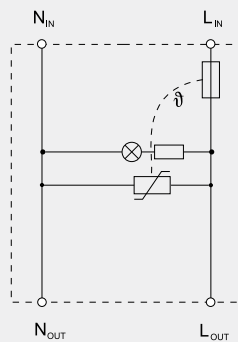

BRLED-DIN-NG

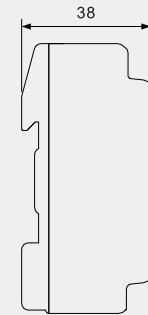
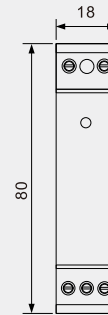

		BRLED-DIN	BRLED-DIN-NG
SPD classification according to EN61643 -11		Type 2+Type 3	Type 2+Type 3
SPD classification according to IEC61643-11		Class II+Class III	Class II+Class III
Nominal a.c. voltage	Un	230V	230V
Max. continuous operating a.c. voltage	Uc	320V	320V
Nominal discharge current (8/20μs)	In	5kA	5kA
Max. discharge current (8/20μs)	Imax	10kA	10kA
Voltage protection level	Up	≤1.5kV	≤1.5kV
Nominal current	IL	5A	5A
Combined impulse	Uoc	10kV	10kV
Response time	tA	≤25ns	≤25ns
Operating temperature range	Tu	-40°C-80°C	-40°C-80°C
Operating state/fault indication		Green light on: OK / light off: Replace	Green light on: OK / light off: Replace
For mounting on		35mm Din rail	35mm Din rail
Enclosure material		Thermoplastic UL94-V0	Thermoplastic UL94-V0
Degree of protection		IP20	IP20
Order Code		B6017	B6018



BRLED-DIN-MD

Surge Arresters for LED

With mechanical indicator

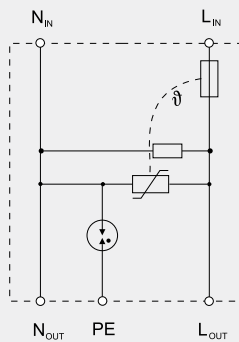

BRLED-DIN-MD

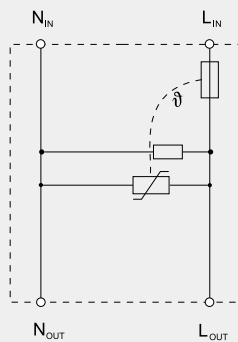

BRLED-DIN-MD-NG

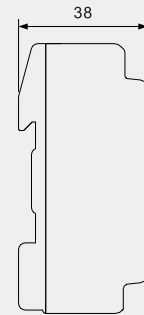
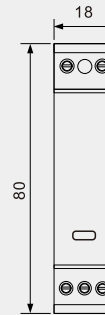

		BRLED-DIN-MD	BRLED-DIN-MD-NG
SPD classification according to EN61643 -11		Type 2+Type 3	Type 2+Type 3
SPD classification according to IEC61643-11		Class II+Class III	Class II+Class III
Nominal a.c. voltage	U _n	230V	230V
Max. continuous operating a.c. voltage	U _c	320V	320V
Nominal discharge current (8/20μs)	I _n	5kA	5kA
Max. discharge current (8/20μs)	I _{max}	10kA	10kA
Voltage protection level	U _p	≤1.5kV	≤1.5kV
Nominal current	I _L	5A	5A
Combined impulse	U _{oc}	10kV	10kV
Response time	t _A	≤25ns	≤25ns
Operating temperature range	T _u	-40°C–80°C	-40°C–80°C
Operating state/fault indication		green/red	green/red
For mounting on		35mm Din rail	35mm Din rail
Enclosure material		Thermoplastic UL94-V0	Thermoplastic UL94-V0
Degree of protection		IP20	IP20
Order Code		B6019	B6020