

BRITEC

Let all the circuits
get surge protected



Britec Electric Co., Ltd.

www.britecelectric.com



Company Profile

Britec Electric specialized in research and development of lightning protection devices, breakers, fuses and other circuit protection products.

Our products are produced under IEC standard and are 100% tested before leaving factory. Part of the products are certified by Intertek SEMKO, TUV and CE.

Our technical department can develop products according to customer's requirement. We can make the tooling in 45 days. If you have special products needs OEM, we are your ideal partner.

Fully understand the ISO9000 quality management system, the company strictly control the supplier and material for production, the assembly process is standardized and the final checking to be done automatically.

With strict quality control, our products can compete with top brands in the market. We are looking for agents and distributors for our products and is willing to accept OEM orders for customers with same mentality.



Basic Knowledge of Lightning Protection

Lightning Protection Zone

Failures of technical systems and installations cause trouble and economic losses. These require faultless operation from the equipment both under “normal” conditions and in case of thunderstorms.

Loss reports of insurance companies show clearly that nearly a quarter of the private damage and 45% of commercial damage are due to surge. A comprehensive protection concept would help to eliminate the damage from the surge.

The Lightning Protection Zones Concept enables designers, constructors and operators to plan, perform and control protection measures. All relevant devices, installations and systems are thus reliably protected with economically acceptable efforts.

Sources of interference

Surges arising due to thunderstorms are caused by direct or close lightning strokes or distant lightning strokes (Fig. 1).

Direct or close lightning strokes are strokes into the lightning protection system of a structure, into its immediate surroundings or into the conductive systems entering the structure (e.g. low-voltage power supply, telecommunications lines and control lines...).

Due to their amplitudes and energy loads, the arising impulse currents and impulse voltages as well as the corresponding electromagnetic field (LEMP) represent a special risk for the system.

In case of a close or direct lightning strike, the surges (Fig. 1: Case 1.1) are caused by a voltage drop at the impulse earthing resistance and the resulting potential rise of the structure towards the distant surroundings. This is the maximum load on electrical installations in structures.

The characteristic parameters of flowing impulse currents (peak value, rate of current rise, load, specific energy) can be described with the impulse-current wave form 10/350 μ s (Fig. 2) and are defined in international, European and national standards as test currents for components and devices for protection against direct lightning strokes. In addition to the voltage drop at the impulse earthing resistance, surges arise in the electrical building installation and the systems connected to it and equipment due to the induction effect of the electromagnetic lightning field (Fig 1: Case 1.2).

The power of these induced surges and the resulting impulse currents is considerably lower than the power of a direct lightning impulse current and is therefore only described with the impulse current wave 8/20 μ s (Fig. 2).

Components and equipment, which do not have to conduct currents from direct lightning strokes, are therefore tested with impulse currents of 8/20 μ s.

Protection philosophy

Distant strokes are lightning strokes from a distance to the object to be protected, lightning strokes into the medium voltage overhead line network or into its immediate surroundings or lightning discharges from cloud to cloud (Fig. 1: Cases 2.1, 2.2 and 2.3).

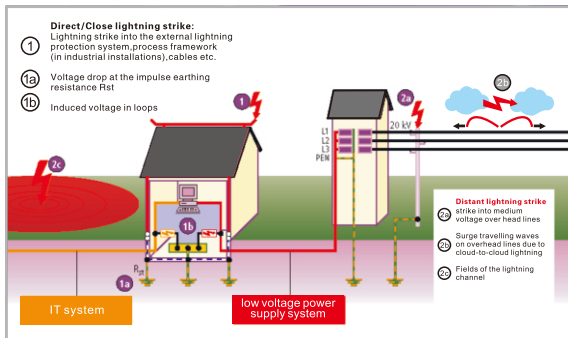

Fig. 1

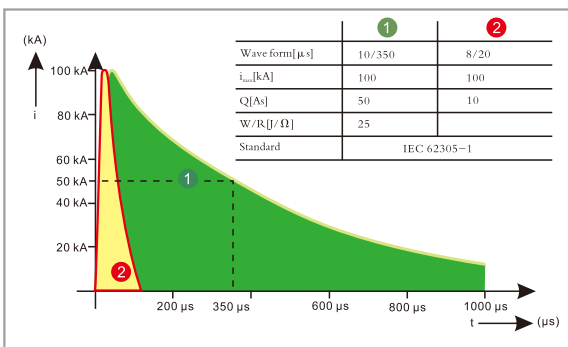
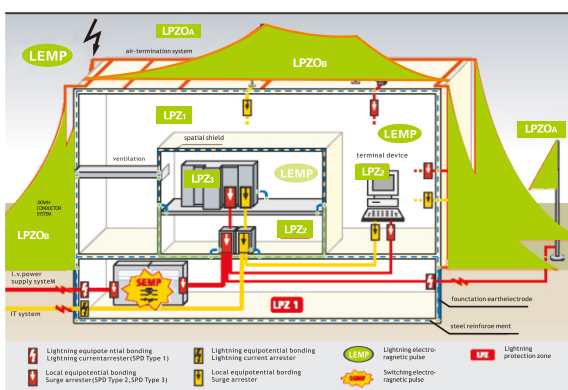

Fig. 2



LEMP

In analogy to induced surges, the effects of distant lightning strokes on the electrical system of a structure are controlled by devices and components, which are designed accordingly for impulse current wave 8/20 μ s.

Surges due to switching operations (SEMP) are caused by e.g. switching off inductive load (e.g. transformers, coils, motors), ignition and interruption of electric arcs (e.g. arc welding device), tripping of fuses.

The effects of switching operations in electrical installations of structures can also be simulated with impulse currents of wave form 8/20 μ s for testing purposes.

LEMP protection of structures with electrical and electronic systems according to IEC 62305-4

Lightning Protection Zone	Description
LPZ 0A	Threat by direct lightning strokes, impulse currents up to complete lightning currents and the entire lightning field.
LPZ 0B	Protected against direct lightning strokes. Threat by impulse currents up to partial lightning currents and the entire lightning field.
LPZ 1	Impulse currents are further limited by current distribution and SPDs situated at the zone boundaries. The lightning field is mostly attenuated by spatial shielding.
LPZ 2	Impulse currents are further limited by current distribution and SPDs situated at the zone boundaries. The lightning field is mostly attenuated by spatial shielding.

Power Distribution System:

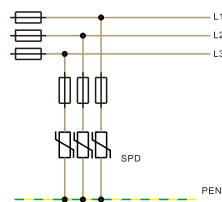

SPD in TN-C system

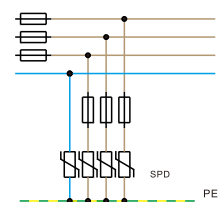

SPD in TN-S system

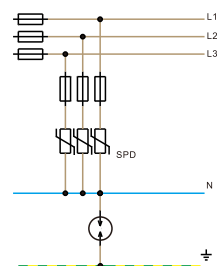

SPD in TT system

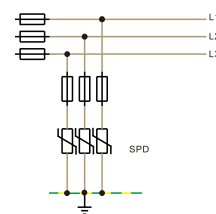

SPD in IT system



Type of surge protectors

The AC power surge protectors have 3 categories by IEC 61643-11 and EN 61643-11 standards, with the following 3 classes of tests. These different tests depend on the location of the surge protector in the AC network and on the external conditions.

Type 1 surge protectors

Type 1 surge protectors are designed to be installed where a direct lightning strike risk is high, especially when the building is equipped with external lightning protection system (LPS or lightning rod). In this situation, EN 61643-11 and IEC 61643-11 standards require the Class I test to be applied to surge protectors : this test is characterized by applying 10/350 μ s impulse current in order to simulate the direct lightning strike consequence. Therefore these Type 1 surge protectors must be especially powerful to conduct this high energy impulse current.

Type 2 surge protectors

Type 2 surge protectors are designed to be installed at the entrance of the installation, in the main switchboard, or close to sensitive terminals, on installations without LPS (lightning rods). These protectors are tested following the Class II test from IEC61643-11 or EN61643-11 standards and based on 8/20 μ s impulse current

Type 3 surge protectors

In case of very sensitive or remote equipment, secondary stage of surge protectors is required : these low energy SPDs could be Type 2 or Type 3 (see Coordination of surge protector page 7). Type 3 SPDs are tested with a combination waveform 1,2/50 μ s voltage - 8/20 μ s current following Class III test.

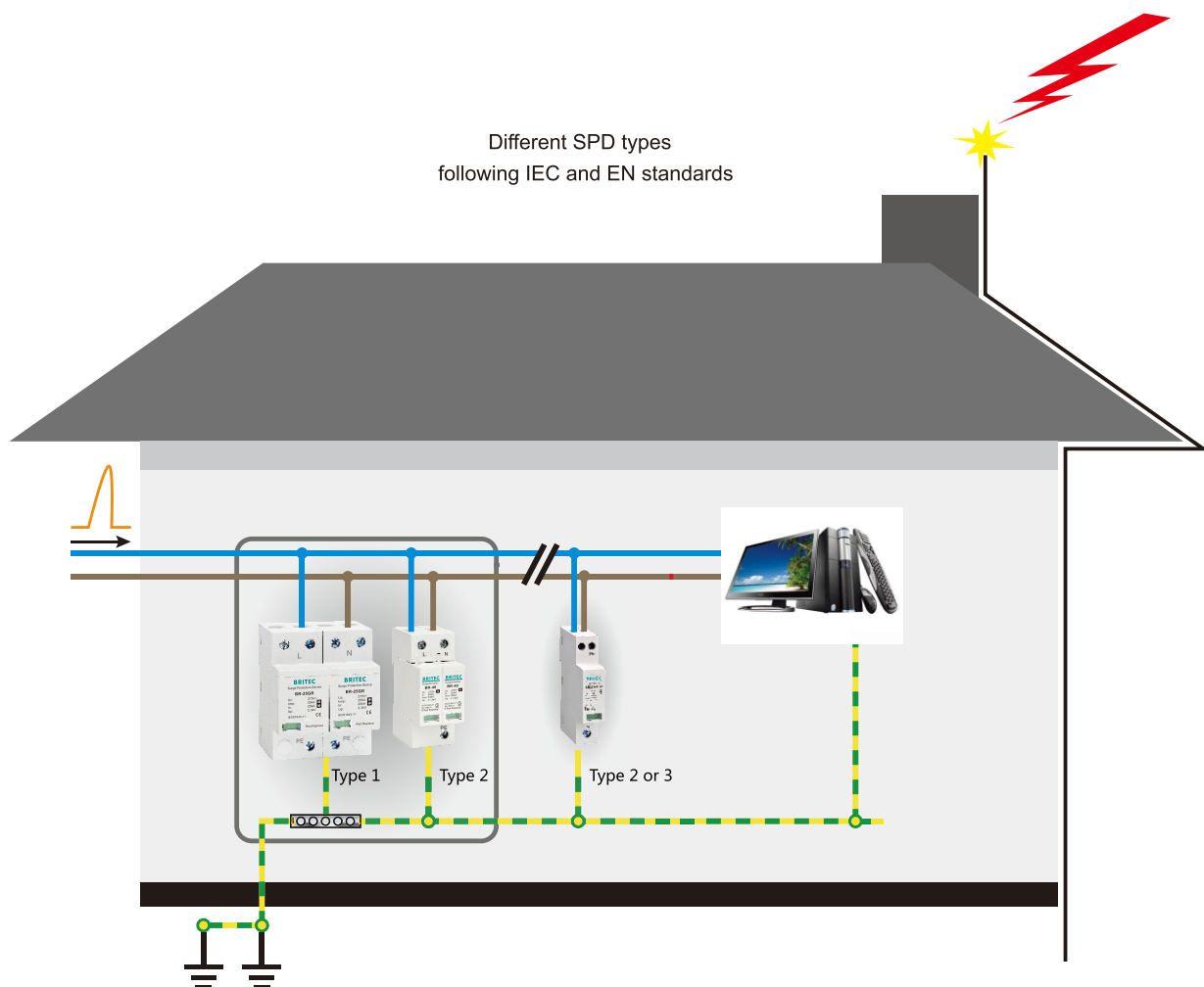

Maintenance

BR surge protectors are designed for repetitive operation and do not require specific maintenance. Nevertheless, in case of an extreme event, a controlled end of life could occur (see above) and a maintenance operation must be performed.

Pluggable design

The design of some BR surge protectors (BR-20, BR-40, BR-80 and BR-12.5M) is based on the use of a pluggable module that plugs into a matching base. This makes replacement, and checking very easy without impairing the protection function. On multipolar surge protectors, the possibility of replacing a single pole makes rehabilitating a surge protector less expensive.

Status Indication

BR surge protectors are equipped with a failure indicator (mechanical or light) linked to the internal thermal disconnect: in case of safety disconnection, the indicator will switch on and the SPD must be replaced.

Remote Signaling

Most BR surge protectors are available in remote signaling versions. This feature, which allows remote checking of the status of the surge protector, is especially important when the products are hard to reach or unsupervised.

The system consists of an auxiliary changeover contact that is activated if the surge protector module changes status.

This lets the user monitor :

- the good operation of the SPD
- the presence of the plug-in modules (if any)
- the end of life (disconnection) of the surge protector.

The remote signaling version allows the choice of signaling system appropriate to the installation (light, buzzer, automation, modem transmission...).

Disconnection devices

In compliance with the standards, the AC power surge protectors are equipped with external and internal disconnection devices in order to provide total safety in case of failure.

2 types of devices are necessary :

Internal thermal security which will disconnect the surge protector from the AC network in case of thermal runaway. In such a case, the user will be warned about the trouble by an indicator (mechanical or light) in front of the protector and will carry out the replacement of the defective SPD.

External electrical disconnecter (fuses or breaker) to disconnect the surge protector from the AC network in case of internal short circuit, e.g. due to an excessive impulse current. The rating of the external fuses (or breaker) are in relation with the discharge capability of the SPD and the prospective short-circuit current of the installation and must be tested together with the surge protector in order to ensure compliance of the short-circuit current withstand test (Iscpr parameter). To ease the selection of these components, the rating and type of fuses (or breaker) are mentioned in the datasheet and in the installation instructions of each SPD (see Backup Fuses page 4).

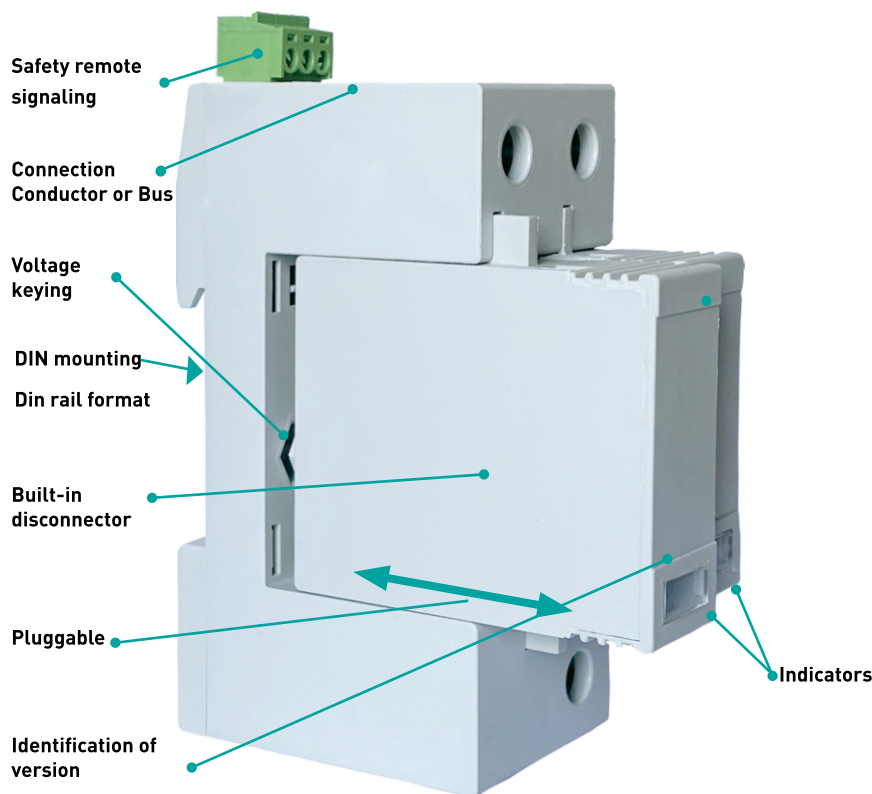



Surge protection installation

Installation Location

BR surge protectors are installed as follows, according to their types:

- **Type 1 or Heavy duty:** at the origin of the installation, in a separate box or on the main electrical panel, for efficient discharge of partial lightning currents.
- **Type 2 or Primary:** at the origin of the installation, on the main electrical panel, in order to eliminate impulses currents as fast as possible and thereby avoid coupling.
- **Type 2 (or Type 3) or Secondary:** on the secondary panel, near the sensitive equipment, to limit ringing and improve the level of protection.

Wiring

Since lightning surges are essentially common-mode phenomena, BR surge protectors are connected mainly in common mode (between the active conductors and ground).

Some recommendations call for additional differential-mode protection (between phase and neutral). For these applications, BRITEC offers specific versions, using a gas tube base module for the Neutral to Ground (differential mode) protection: this type of installation is called a CT2 connection in IEC 60364 standard, is used in surge protectors such as BR-40 3+1.

Common mode protection -CT1 Connection

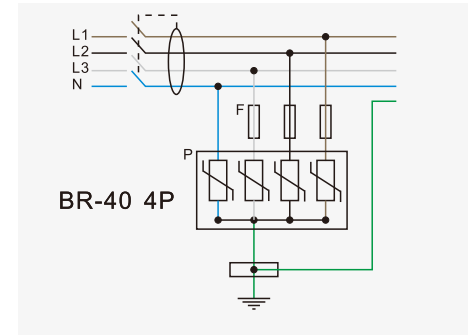

Common and differential mode protection -CT2 Connection

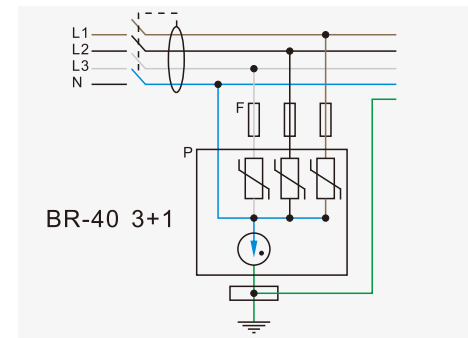

Backup fuses

To comply with standards and safety, the AC surge protectors must be protected against a possible end of life in short-circuit: the user must install on each SPD branch, a protection against short-circuit current (fuses or breaker).

The rating of this fuses is given by the SPD manufacturer in the product datasheet or installation instructions. The choice of this rating eria: depends of 2 criteria :

- Withstand of the short-circuit current tes in the IEC 61643-11 standard: the fuse must cut safety the short-circuit current before an harsh destruction of the SPD.
- Withstand of the discharge currents (I_n or I_{imp}): the fuse must be able to conduct the discharge current of the SPD without blowing.

BRITEC has selected some fuses and DIN rail holders to fit with his SPD range. The fuses equipped with failure indicators to check easily their operating status.

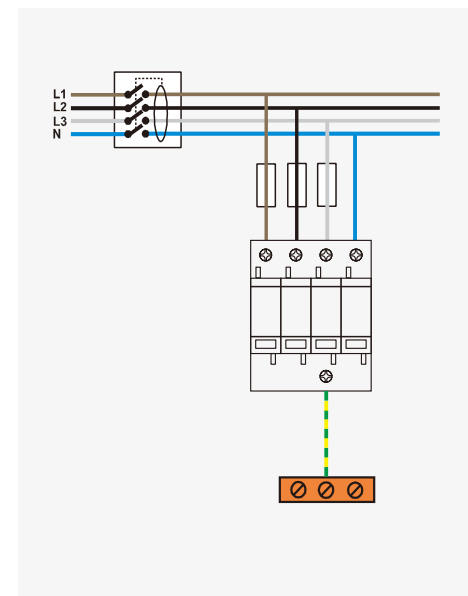



Installation

BR surge protectors are connected in parallel on the AC network and must be equipped with external fuses (or breakers) for short-circuit protection (see paragraph Backup Fuses).

- The total length of connection wires to AC network must be lower than 0.5 m in order not to increase the protection level(Up) provided by the SPD.
- Wiring is made by screw connections. On some models, a distribution bus can be used.
- The protection wire coming from the SPD must be connected to the bonding bar of the electrical panel. Paralleling the protection wire with phases conductors must be avoided.
- The cross sectional wire must be 6 mm² minimum for Type 2 SPD's and 16 mm² for Type 1.
- Local earthing resistance must be in compliance with the electrical rules.

Further information can be found in IEC 61643-12 standard (selection and application principles for low voltage SPD).

Installation example (Type 2 surge arrester BR-40 3+1)

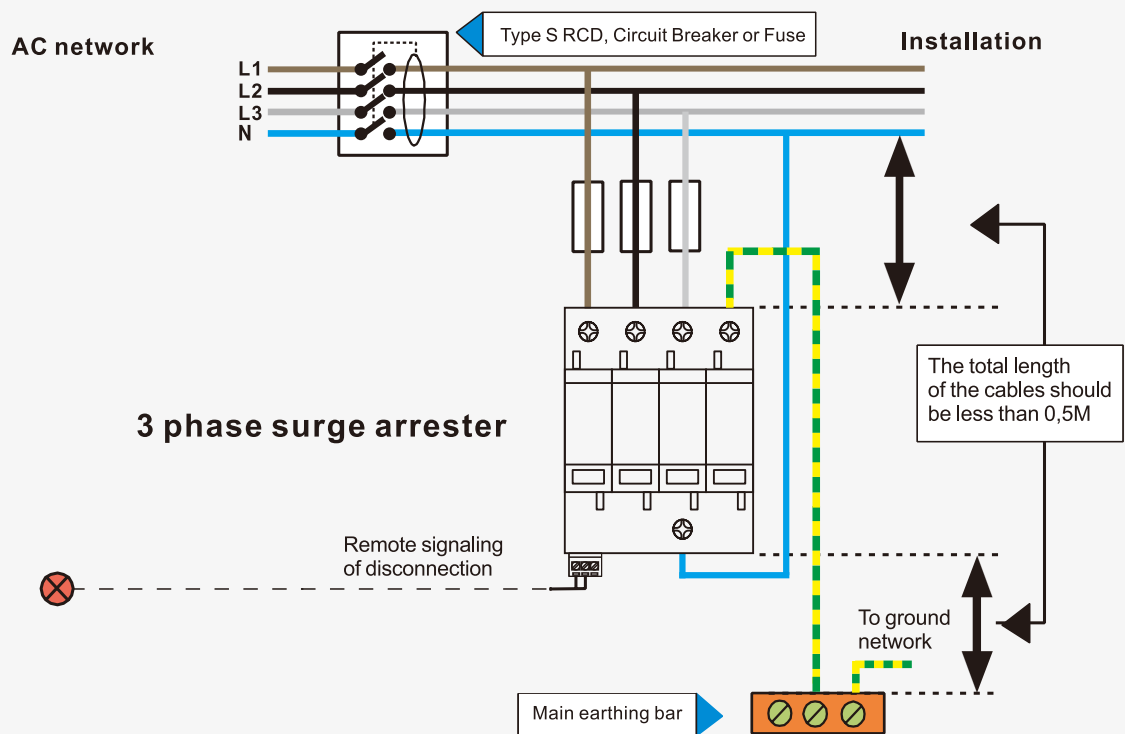



Choosing Surge Protectors

BRITEC's line of AC power surge protectors is designed to cover all possible configurations in low voltage installations. They are available in many versions, which differ in:

- Type or test class (1, 2 or 3)
- Operating voltage (Uc)
- AC network configuration (Single/3-Phase)
- Discharge currents (Iimp, I_{max}, I_n)
- Protection level (Up)
- Protection technology (varistors, VG technology, filter)
- Features (differential mode, plug-in, remote signaling, compact..).

The surge protection selection must be done following the local electrical code requirements (e.g. : minimum rating for I_n) and specific conditions (e.g. : high lightning density).

Choosing the Type of surge protectors

The type of surge protector is based on its location and the constraints of the installation to be protected.

ConfigurationSPD	Type	Location	BRITEC
Installation equipped with LPS or could be hit by lightning	Type 1+2 Type 1+2+3	Origin of the installation origin (Panel or main switchboard)	BR-25GR BR-50GR BR-7M BR-12.5M BR-25M
Installation without LPS	Type 2 Type 2+3	main switchboard	BR-20, BR-40 BR-80, BR-100
Secondary protection (downstream primary SPD)	Type 2 (or Type 3)	close to protected equipment	BR-15DP BR-20DP BR275-6

Choosing the operating voltages Uc and UT

The SPD Uc voltage (maximum continuous operating voltage) depends on:

- Nominal voltage of the AC network (U_o)
- Type of AC system (TN, TT, IT).

The level of resistance to temporary overvoltages (UT) is related to the Uc voltage. In addition, withstanding the "high voltage" TOV (1200 Vac, 300A, 200 ms) between Neutral and PE is needed in TT AC system, which requires the CT2 diagram.

Operating voltage Uc (Line/Ground)

AC Network	230/400V			120/208V
	TT	TN	IT	TN
Voltage Uc mini	255V	255V	440V	135V
Voltage U _T	335/440V	335/440V	-	230/175V
TOV N/PE	1200V			
Example of BRITEC product	BR-40 275TT	BR-40 275	BR-40 400	BR-40 150

AC network configuration

BR surge protectors are available for single, 3-Phase and 3-Phase + neutral AC networks.

Choosing Iimp

The impulse current Iimp is defined for Type 1 SPD. The minimum rating for Iimp is 12.5 kA by pole, following IEC 60364-5- 534 . This level is adapted to the real phenomenon. This value can, however, be increased according to the risk (calculation according to EN 62305-1) BRITEC proposes, in its Type 1 SPD range, 3 levels of Iimp current by pole: 12.5, 25 and 50 kA.

Configuration	Iimp/pole	BRITEC
Maximum risk	50 kA	BR-50GR
Very high lightning density Bad earthing	25 kA	BR-25GR BR-25M
High, medium or low lightning density	12.5 kA	BR-12.5GR BR-12.5M

Choosing I_n current

The relevant nominal discharge current I_n for the SPD is in relation with the lightning risk in the installation area.

The minimum rating of I_n for a SPD connected at the installation entrance is 5 kA (8/20 μs waveform), required by standard. Nevertheless higher ratings are advised in case of high lightning density. Moreover higher values of I_n current will increase the SPD lifetime. I_{max} (max. discharge current) rating is linked to I_n.

Conditions	I _n	BRITEC
Very high lightning density	> 20 kA	BR-80
High or medium lightning density	10-20 kA	BR-40 BR-20
Low lightning density or secondary SPD	5 kA	BR-10DP BR275-6

Choosing the protection level Up

The user must select a surge protector with a protection level Up adapted to the withstand level of terminal equipment. In every case, the lower the protection level Up, the better the protection.

IEC 60364 standard calls for the minimum protection level of 2.5 kV for a SPD connected at the entrance of a 230/400 V network : this level is in compliance with the withstand of robust devices (electromechanical type).

Electronic-based terminals have lower impulse withstand and require a better protection : so, surge protectors with 1.5 kV protection are necessary to provide efficient protection.

Conditions	Recommended Up	
	230/400 V AC network	120/208 V AC network
SPD at the installation entrance	2.5 kV max.	1.5 kV max.
Electromechanical protected equipment	2.5 kV	1.5 kV
Electronic-based protected equipment	1.5 kV	0.8 kV

Choosing the SPD technology

A relevant choice of the SPD technology, as well as the use of coordination diagram can help to improve the protection level.

BR surge protectors are based on Varistor (MOV) technology.

Some versions use different electrical diagrams in order to improve some of their characteristics :

-VG technology:

this Gas tube-Varistor combined SPD improves the reliability and and the efficiency.

- Multigap sparkgap technology

This kind of surge protector can discharge large impulse current.

It can also has a high follow up current due to the product consists by many sparkgaps

Product such as BR-25GR and BR-12.5GR are based on this technology.

This coordination is required in the 2 following cases :

-High sensitivity equipment :

➔ Improvement of protection level.

- Long distance (greater than 30 m) of wire between equipment to be protected and primary SPD :

➔ Reduction of ringing voltages created during the surge transmission.

Efficient SPD coordination is performed by including between primary and secondary SPDs :

- a minimum length of wire (> 10 m).

or

- a decoupling coil.

Coordination of Surge Protector

Coordination of Surge Protectors

In order to provide maximum protection efficiency, it is necessary to create a coordination diagram, that means installation of a primary SPD at the network entrance and a secondary close to sensitive equipment.

Coordination by conductor

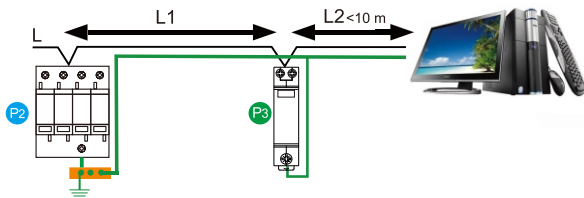

In order to provide maximum protection efficiency, it is necessary to create a coordination diagram: that means installation of a primary SPD at the network entrance and a secondary close to sensitive equipment.

Efficient SPD coordination is performed by including, between primary and secondary SPDs :

-a minimum length of wire (> 10 m).

or

-coordination inductors (BR-CC range: see below).

Coordination by inductor

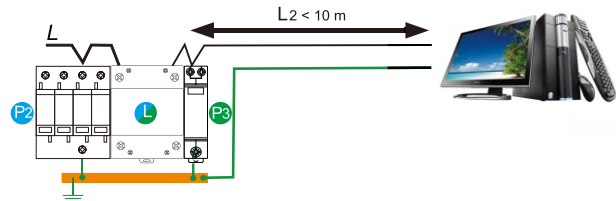

P2 : Primary surge protector (ex. BR-40)

P3 : Secondary surge protector (ex. BR-20DP)

L : Coordination inductors (ex. BR-CC)

L1 : Length of conductor between surge protector

L2 : Length of conductor between surge protector and installation

Example of coordination on 3-Phase network.

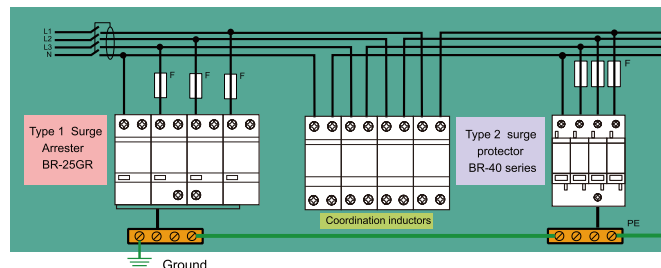

D : Breaker
F : Backup disconnector (fuse or circuit-breaker)
L : Coordination inductor

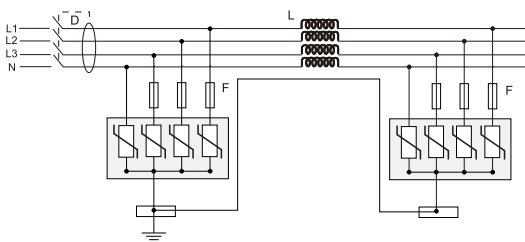

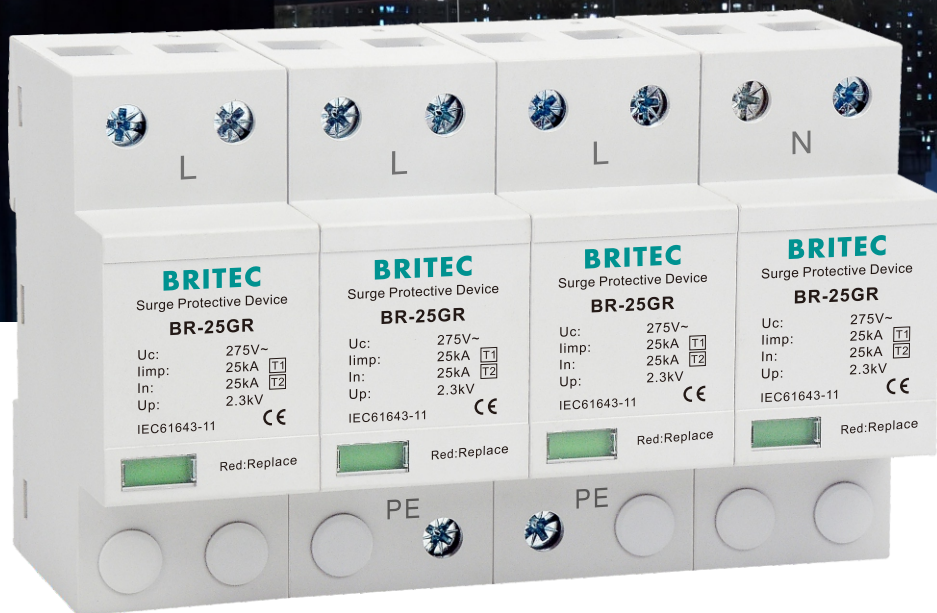

Type 1 Surge Arrester

www.britecelectric.com

BR-50GR 4P

Type1 Surge Arrester

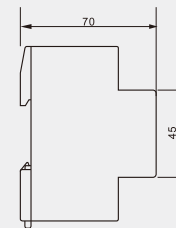
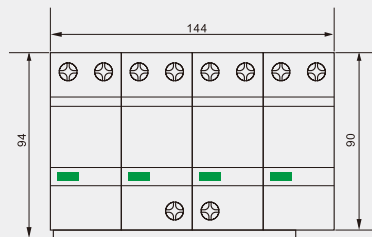
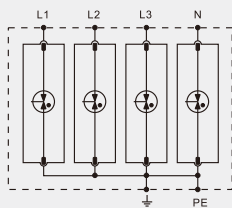

■ BR-50GR 4P is suitable for TN-S system.

	BR-50GR 150 4P	BR-50GR 275 4P	BR-50GR 320 4P
SPD classification according to EN61643-11	Type 1 + Type 2	Type 1 + Type 2	Type 1 + Type 2
SPD classification according to IEC61643-11	Class I + Class II	Class I + Class II	Class I + Class II
Max. continuous operating a.c. voltage	Uc	150V (50/60Hz)	275V (50/60Hz)
Lightning impulse current (10/350µs)	Iimp	50kA	50kA
Nominal discharge current (8/20µs)	In	50kA	50kA
Maximum discharge current (8/20µs)	I _{max}	200kA	200kA
Quantity of electric charge	Q	25As	25As
Specific energy	W/R	625kJ/Ω	625kJ/Ω
Voltage protection level	Up	≤ 2.3kV	≤ 2.3kV
Short-circuit current rating a.c.	I _{sc}	25kA rms	25kA rms
Max. backup fuse		350A gG	350A gG
Temporary overvoltage	TOV	440V/120min -withstand	440V/120min -withstand
Response time	t _A	≤ 100ns	≤ 100ns
Operating temperature range	T _u	-40°C-80°C	-40°C-80°C
Cross-section area (Min.)		4mm ²	4mm ²
Cross-section area(Max.)		35mm ²	35mm ²
For mounting on		35mm Din rail	35mm Din rail
Enclosure material		Thermoplastic UL94-V0	Thermoplastic UL94-V0
Degree of protection		IP20	IP20
Order Code		B7158	B7184
Order Code (With remote signaling)		B7159	B7185

BR-50GR 3P Type1 Surge Arrester

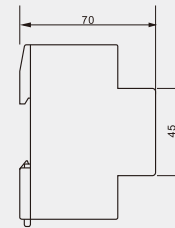
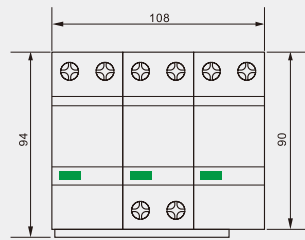
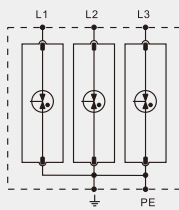

■ BR-50GR 3P is suitable for TN-C system.

	BR-50GR 150 3P	BR-50GR 275 3P	BR-50GR 320 3P
SPD classification according to EN61643-11	Type 1 + Type 2	Type 1 + Type 2	Type 1 + Type 2
SPD classification according to IEC61643-11	Class I + Class II	Class I + Class II	Class I + Class II
Max. continuous operating a.c. voltage	Uc	150V (50/60Hz)	275V (50/60Hz)
Lightning impulse current (10/350µs)	Iimp	50kA	50kA
Nominal discharge current (8/20µs)	In	50kA	50kA
Maximum discharge current (8/20µs)	I _{max}	200kA	200kA
Quantity of electric charge	Q	25As	25As
Specific energy	W/R	625kJ/Ω	625kJ/Ω
Voltage protection level	Up	≤ 2.3kV	≤ 2.3kV
Short-circuit current rating a.c.	I _{sc}	25kA rms	25kA rms
Max. backup fuse		350A gG	350A gG
Temporary overvoltage	TOV	440V/120min -withstand	440V/120min -withstand
Response time	t _A	≤ 100ns	≤ 100ns
Operating temperature range	T _u	-40°C-80°C	-40°C-80°C
Cross-section area (Min.)		4mm ²	4mm ²
Cross-section area(Max.)		35mm ²	35mm ²
For mounting on		35mm Din rail	35mm Din rail
Enclosure material		Thermoplastic UL94-V0	Thermoplastic UL94-V0
Degree of protection		IP20	IP20
Order Code		B7160	B7186
Order Code (With remote signaling)		B7161	B7187

BR-50GR 2P Type 1 Surge Arrester

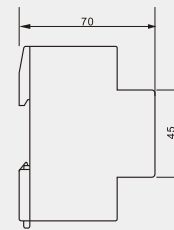
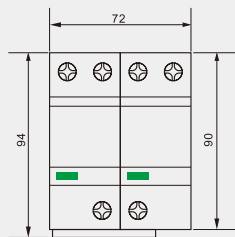
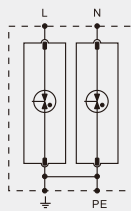

BR-50GR 2P surge arrester is suitable for single phase TN system.

	BR-50GR 150 2P	BR-50GR 275 2P	BR-50GR 320 2P
SPD classification according to EN61643-11	Type 1 + Type 2	Type 1 + Type 2	Type 1 + Type 2
SPD classification according to IEC61643-11	Class I + Class II	Class I + Class II	Class I + Class II
Max. continuous operating a.c. voltage	Uc	150V (50/60Hz)	275V (50/60Hz)
Lightning impulse current (10/350µs)	Iimp	50kA	50kA
Nominal discharge current (8/20µs)	In	50kA	50kA
Maximum discharge current (8/20µs)	Imax	200kA	200kA
Quantity of electric charge	Q	25As	25As
Specific energy	W/R	625kJ/Ω	625kJ/Ω
Voltage protection level	Up	≤ 2.3kV	≤ 2.3kV
Short-circuit current rating a.c.	Isccr	25kA rms	25kA rms
Max. backup fuse		350A gG	350A gG
Temporary overvoltage	TOV	440V/120min -withstand	440V/120min -withstand
Response time	tA	≤ 100ns	≤ 100ns
Operating temperature range	Tu	-40°C-80°C	-40°C-80°C
Cross-section area (Min.)		4mm ²	4mm ²
Cross-section area(Max.)		35mm ²	35mm ²
For mounting on		35mm Din rail	35mm Din rail
Enclosure material		Thermoplastic UL94-V0	Thermoplastic UL94-V0
Degree of protection		IP20	IP20
Order Code		B7162	B7188
Order Code (With remote signaling)		B7163	B7189

BR-50GR 1P

Type 1 Surge Arrester

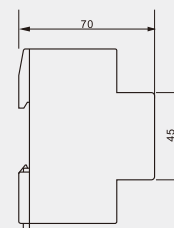
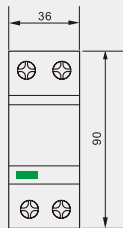
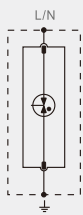

BR-50GR 1P can be used to build 2P, 3P and 4P surge arresters.

	BR-50GR 150 1P	BR-50GR 275 1P	BR-50GR 320 1P
SPD classification according to EN61643-11	Type 1 + Type 2	Type 1 + Type 2	Type 1 + Type 2
SPD classification according to IEC61643-11	Class I + Class II	Class I + Class II	Class I + Class II
Max. continuous operating a.c. voltage	Uc	150V (50/60Hz)	275V (50/60Hz)
Lightning impulse current (10/350µs)	Iimp	50kA	50kA
Nominal discharge current (8/20µs)	In	50kA	50kA
Maximum discharge current (8/20µs)	I _{max}	200kA	200kA
Quantity of electric charge	Q	25As	25As
Specific energy	W/R	625kJ/Ω	625kJ/Ω
Voltage protection level	Up	≤ 2.3kV	≤ 2.3kV
Short-circuit current rating a.c.	I _{sc}	25kA rms	25kA rms
Max. backup fuse		350A gG	350A gG
Temporary overvoltage	TOV	440V/120min -withstand	440V/120min -withstand
Response time	t _A	≤ 100ns	≤ 100ns
Operating temperature range	T _u	-40°C-80°C	-40°C-80°C
Cross-section area (Min.)		4mm ²	4mm ²
Cross-section area(Max.)		35mm ²	35mm ²
For mounting on		35mm Din rail	35mm Din rail
Enclosure material		Thermoplastic UL94-V0	Thermoplastic UL94-V0
Degree of protection		IP20	IP20
Order Code		B7164	B7190
Order Code (With remote signaling)		B7165	B7191

BR-50GR 3+1 Type 1 Surge Arrester

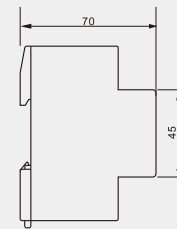
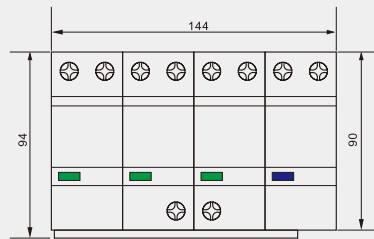
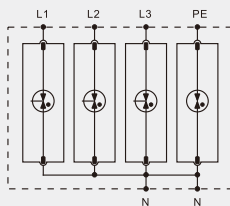

■ BR-50GR 3+1 surge arrester is suitable for TT and TN-S system.

		BR-50GR 150 3+1	BR-50GR 275 3+1	BR-50GR 320 3+1
SPD classification according to EN61643-11		Type 1 + Type 2	Type 1 + Type 2	Type 1 + Type 2
SPD classification according to IEC61643-11		Class I + Class II	Class I + Class II	Class I + Class II
Max. continuous operating a.c. voltage	U_c (L-N/N-PE)	150V/255V (50/60Hz)	275V/255V (50/60Hz)	320V/255V (50/60Hz)
Lightning impulse current (10/350µs)	I_{imp} (L-N/N-PE)	50kA/100kA	50kA/100kA	50kA/100kA
Nominal discharge current (8/20µs)	I_n (L-N/N-PE)	50kA/100kA	50kA/100kA	50kA/100kA
Maximum discharge current (8/20µs)	I_{max} (L-N/N-PE)	200kA/200kA	200kA/200kA	200kA/200kA
Quantity of electric charge (L-N,N-PE)	Q	25As, 50As	25As, 50As	25As, 50As
Specific energy (L-N,N-PE)	W/R	625kJ/Ω, 2500kJ/Ω	625kJ/Ω, 2500kJ/Ω	625kJ/Ω, 2500kJ/Ω
Voltage protection level	U_p (L-N/N-PE)	≤ 2.3kV/≤ 1.5kV	≤ 2.3kV/≤ 1.5kV	≤ 2.3kV/≤ 1.5kV
Short-circuit current rating a.c.	I_{scCR} (L-N/N-PE)	25kA rms/100A rms	25kA rms/100A rms	25kA rms/100A rms
Max. backup fuse		350A gG	350A gG	350A gG
Temporary overvoltage	TOV (L-N)	440V/120min -withstand	440V/120min -withstand	440V/120min -withstand
Temporary overvoltage	TOV (N-PE)	1200V/200ms -withstand	1200V/200ms -withstand	1200V/200ms -withstand
Response time	t_A	≤ 100ns	≤ 100ns	≤ 100ns
Operating temperature range	T_u	-40°C-80°C	-40°C-80°C	-40°C-80°C
Cross-section area (Min.)		4mm ²	4mm ²	4mm ²
Cross-section area(Max.)		35mm ²	35mm ²	35mm ²
For mounting on		35mm Din rail	35mm Din rail	35mm Din rail
Enclosure material		Thermoplastic UL94-V0	Thermoplastic UL94-V0	Thermoplastic UL94-V0
Degree of protection		IP20	IP20	IP20
Order Code		B7166	B8167	B7192
Order Code (With remote signaling)		B7167	B8168	B7193

BR-50GR 1+1 Type 1 Surge Arrester

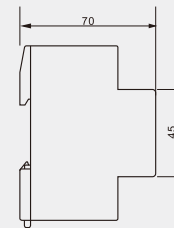
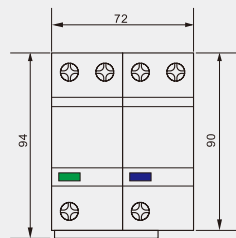
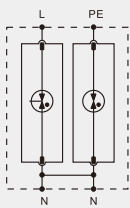
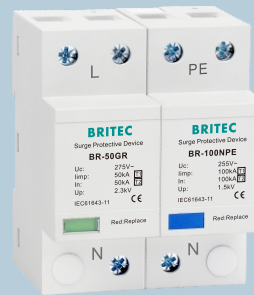

■ BR-50GR 1+1 surge arrester is suitable for TT and TN-S system.

		BR-50GR 150 1+1	BR-50GR 275 1+1	BR-50GR 320 1+1
SPD classification according to EN61643-11		Type 1 + Type 2	Type 1 + Type 2	Type 1 + Type 2
SPD classification according to IEC61643-11		Class I + Class II	Class I + Class II	Class I + Class II
Max. continuous operating a.c. voltage	Uc (L-N/N-PE)	150V/255V (50/60Hz)	275V/255V (50/60Hz)	320V/255V (50/60Hz)
Lightning impulse current (10/350µs)	Iimp (L-N/N-PE)	50kA/100kA	50kA/100kA	50kA/100kA
Nominal discharge current (8/20µs)	In (L-N/N-PE)	50kA/100kA	50kA/100kA	50kA/100kA
Maximum discharge current (8/20µs)	I _{max} (L-N/N-PE)	200kA/200kA	200kA/200kA	200kA/200kA
Quantity of electric charge (L-N,N-PE)	Q	25As, 50As	25As, 50As	25As, 50As
Specific energy (L-N,N-PE)	W/R	625kJ/Ω, 2500kJ/Ω	625kJ/Ω, 2500kJ/Ω	625kJ/Ω, 2500kJ/Ω
Voltage protection level	Up (L-N/N-PE)	≤ 2.3kV/≤ 1.5kV	≤ 2.3kV/≤ 1.5kV	≤ 2.3kV/≤ 1.5kV
Short-circuit current rating a.c.	Isc cr (L-N/N-PE)	25kA rms/100A rms	25kA rms/100A rms	25kA rms/100A rms
Max. backup fuse		350A gG	350A gG	350A gG
Temporary overvoltage	TOV (L-N)	440V/120min -withstand	440V/120min -withstand	440V/120min -withstand
Temporary overvoltage	TOV (N-PE)	1200V/200ms -withstand	1200V/200ms -withstand	1200V/200ms -withstand
Response time	t _A	≤ 100ns	≤ 100ns	≤ 100ns
Operating temperature range	T _u	-40°C-80°C	-40°C-80°C	-40°C-80°C
Cross-section area (Min.)		4mm ²	4mm ²	4mm ²
Cross-section area(Max.)		35mm ²	35mm ²	35mm ²
For mounting on		35mm Din rail	35mm Din rail	35mm Din rail
Enclosure material		Thermoplastic UL94-V0	Thermoplastic UL94-V0	Thermoplastic UL94-V0
Degree of protection		IP20	IP20	IP20
Order Code		B7168	B8157	B7194
Order Code (With remote signaling)		B7169	B8158	B7195



BR-25GR 4P Type1 Surge Arrester

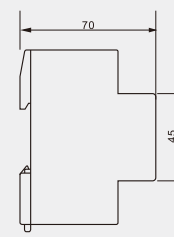
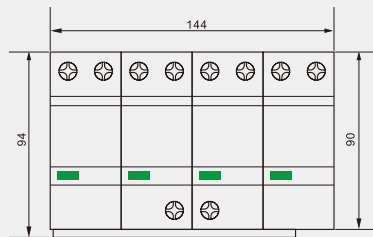
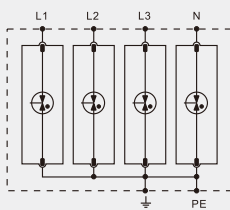
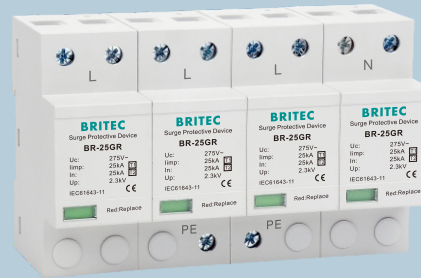

■ BR-25GR 4P is suitable for TN-S system.

	BR-25GR 150 4P	BR-25GR 275 4P	BR-25GR 320 4P
SPD classification according to EN61643-11	Type 1 + Type 2	Type 1 + Type 2	Type 1 + Type 2
SPD classification according to IEC61643-11	Class I + Class II	Class I + Class II	Class I + Class II
Max. continuous operating a.c. voltage	Uc	150V (50/60Hz)	275V (50/60Hz)
Lightning impulse current (10/350µs)	Iimp	25kA	25kA
Nominal discharge current (8/20µs)	In	25kA	25kA
Maximum discharge current (8/20µs)	I _{max}	100kA	100kA
Quantity of electric charge	Q	12.5As	12.5As
Specific energy	W/R	156kJ/Ω	156kJ/Ω
Voltage protection level	Up	≤2.3kV	≤2.3kV
Short-circuit current rating a.c.	I _{sc}	25kA rms	25kA rms
Max. backup fuse		315A gG	315A gG
Temporary overvoltage	TOV	440V/120min -withstand	440V/120min -withstand
Response time	t _A	≤100ns	≤100ns
Operating temperature range	T _u	-40°C-80°C	-40°C-80°C
Cross-section area (Min.)		4mm ²	4mm ²
Cross-section area(Max.)		35mm ²	35mm ²
For mounting on		35mm Din rail	35mm Din rail
Enclosure material		Thermoplastic UL94-V0	Thermoplastic UL94-V0
Degree of protection		IP20	IP20
Order Code		B7120	B7146
Order Code (With remote signaling)		B7121	B7147

BR-25GR 3P Type1 Surge Arrester

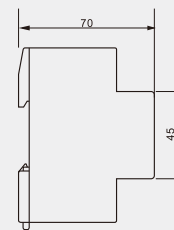
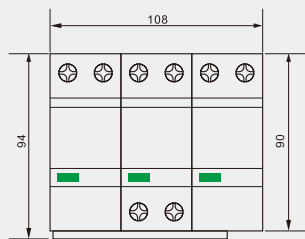
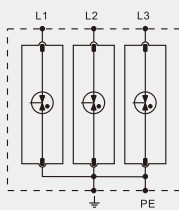

■ BR-25GR 3P is suitable for TN-C system.

	BR-25GR 150 3P	BR-25GR 275 3P	BR-25GR 320 3P
SPD classification according to EN61643-11	Type 1 + Type 2	Type 1 + Type 2	Type 1 + Type 2
SPD classification according to IEC61643-11	Class I + Class II	Class I + Class II	Class I + Class II
Max. continuous operating a.c. voltage	Uc	150V (50/60Hz)	275V (50/60Hz)
Lightning impulse current (10/350µs)	Iimp	25kA	25kA
Nominal discharge current (8/20µs)	In	25kA	25kA
Maximum discharge current (8/20µs)	I _{max}	100kA	100kA
Quantity of electric charge	Q	12.5As	12.5As
Specific energy	W/R	156kJ/Ω	156kJ/Ω
Voltage protection level	Up	≤ 2.3kV	≤ 2.3kV
Short-circuit current rating a.c.	I _{sc}	25kA rms	25kA rms
Max. backup fuse		315A gG	315A gG
Temporary overvoltage	TOV	440V/120min -withstand	440V/120min -withstand
Response time	t _A	≤ 100ns	≤ 100ns
Operating temperature range	T _u	-40°C-80°C	-40°C-80°C
Cross-section area (Min.)		4mm ²	4mm ²
Cross-section area(Max.)		35mm ²	35mm ²
For mounting on		35mm Din rail	35mm Din rail
Enclosure material		Thermoplastic UL94-V0	Thermoplastic UL94-V0
Degree of protection		IP20	IP20
Order Code		B7122	B7135
Order Code (With remote signaling)		B7123	B7136

BR-25GR 2P Type 1 Surge Arrester

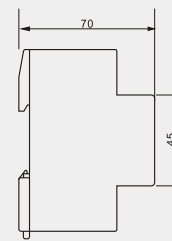
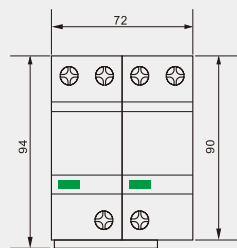
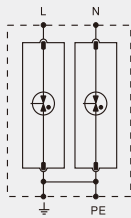

■ BR-25GR 2P surge arrester is suitable for single phase TN system.

	BR-25GR 150 2P	BR-25GR 275 2P	BR-25GR 320 2P
SPD classification according to EN61643-11	Type 1 + Type 2	Type 1 + Type 2	Type 1 + Type 2
SPD classification according to IEC61643-11	Class I + Class II	Class I + Class II	Class I + Class II
Max. continuous operating a.c. voltage	Uc	150V (50/60Hz)	275V (50/60Hz)
Lightning impulse current (10/350µs)	Iimp	25kA	25kA
Nominal discharge current (8/20µs)	In	25kA	25kA
Maximum discharge current (8/20µs)	I _{max}	100kA	100kA
Quantity of electric charge	Q	12.5As	12.5As
Specific energy	W/R	156kJ/Ω	156kJ/Ω
Voltage protection level	Up	≤ 2.3kV	≤ 2.3kV
Short-circuit current rating a.c.	I _{sc}	25kA rms	25kA rms
Max. backup fuse		315A gG	315A gG
Temporary overvoltage	TOV	440V/120min -withstand	440V/120min -withstand
Response time	t _A	≤ 100ns	≤ 100ns
Operating temperature range	T _u	-40°C-80°C	-40°C-80°C
Cross-section area (Min.)		4mm ²	4mm ²
Cross-section area(Max.)		35mm ²	35mm ²
For mounting on		35mm Din rail	35mm Din rail
Enclosure material		Thermoplastic UL94-V0	Thermoplastic UL94-V0
Degree of protection		IP20	IP20
Order Code		B7124	B7150
Order Code (With remote signaling)		B7125	B7151

BR-25GR 1P Type1 Surge Arrester

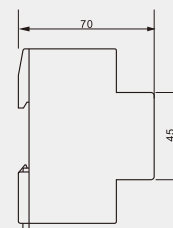
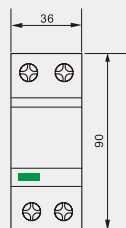
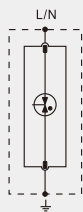

■ BR-25GR 1P can be used to build 2P, 3P and 4P surge arresters.

	BR-25GR 150 1P	BR-25GR 275 1P	BR-25GR 320 1P
SPD classification according to EN61643-11	Type 1 + Type 2	Type 1 + Type 2	Type 1 + Type 2
SPD classification according to IEC61643-11	Class I + Class II	Class I + Class II	Class I + Class II
Max. continuous operating a.c. voltage	Uc	150V (50/60Hz)	275V (50/60Hz)
Lightning impulse current (10/350µs)	Iimp	25kA	25kA
Nominal discharge current (8/20µs)	In	25kA	25kA
Maximum discharge current (8/20µs)	I _{max}	100kA	100kA
Quantity of electric charge	Q	12.5As	12.5As
Specific energy	W/R	156kJ/Ω	156kJ/Ω
Voltage protection level	Up	≤ 2.3kV	≤ 2.3kV
Short-circuit current rating a.c.	I _{sc}	25kA rms	25kA rms
Max. backup fuse		315A gG	315A gG
Temporary overvoltage	TOV	440V/120min -withstand	440V/120min -withstand
Response time	t _A	≤ 100ns	≤ 100ns
Operating temperature range	T _u	-40°C-80°C	-40°C-80°C
Cross-section area (Min.)		4mm ²	4mm ²
Cross-section area(Max.)		35mm ²	35mm ²
For mounting on		35mm Din rail	35mm Din rail
Enclosure material		Thermoplastic UL94-V0	Thermoplastic UL94-V0
Degree of protection		IP20	IP20
Order Code		B7126	B7139
Order Code (With remote signaling)		B7127	B7140

BR-25GR 3+1 Type 1 Surge Arrester

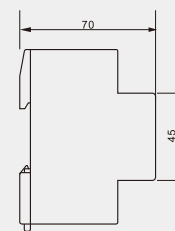
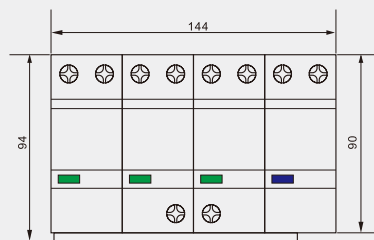
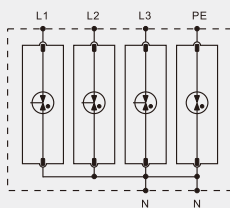

■ BR-25GR 3+1 surge arrester is suitable for TT and TN-S system.

		BR-25GR 150 3+1	BR-25GR 275 3+1	BR-25GR 320 3+1
SPD classification according to EN61643-11		Type 1 + Type 2	Type 1 + Type 2	Type 1 + Type 2
SPD classification according to IEC61643-11		Class I + Class II	Class I + Class II	Class I + Class II
Max. continuous operating a.c. voltage	Uc (L-N/N-PE)	150V/255V (50/60Hz)	275V/255V (50/60Hz)	320V/255V (50/60Hz)
Lightning impulse current (10/350µs)	Iimp (L-N/N-PE)	25kA/100kA	25kA/100kA	25kA/100kA
Nominal discharge current (8/20µs)	In (L-N/N-PE)	25kA/100kA	25kA/100kA	25kA/100kA
Maximum discharge current (8/20µs)	I _{max} (L-N/N-PE)	100kA/200kA	100kA/200kA	100kA/200kA
Quantity of electric charge (L-N,N-PE)	Q	12.5As, 50As	12.5As, 50As	12.5As, 50As
Specific energy (L-N,N-PE)	W/R	156kJ/Ω, 2500kJ/Ω	156kJ/Ω, 2500kJ/Ω	156kJ/Ω, 2500kJ/Ω
Voltage protection level	Up (L-N/N-PE)	≤ 2.3kV/≤ 1.5kV	≤ 2.3kV/≤ 1.5kV	≤ 2.3kV/≤ 1.5kV
Short-circuit current rating a.c.	I _{scrr} (L-N/N-PE)	25kA rms/100A rms	25kA rms/100A rms	25kA rms/100A rms
Max. backup fuse		315A gG	315A gG	315A gG
Temporary overvoltage	TOV (L-N)	440V/120min -withstand	440V/120min -withstand	440V/120min -withstand
Temporary overvoltage	TOV (N-PE)	1200V/200ms -withstand	1200V/200ms -withstand	1200V/200ms -withstand
Response time	t _A	≤ 100ns	≤ 100ns	≤ 100ns
Operating temperature range	T _u	-40°C-80°C	-40°C-80°C	-40°C-80°C
Cross-section area (Min.)		4mm ²	4mm ²	4mm ²
Cross-section area(Max.)		35mm ²	35mm ²	35mm ²
For mounting on		35mm Din rail	35mm Din rail	35mm Din rail
Enclosure material		Thermoplastic UL94-V0	Thermoplastic UL94-V0	Thermoplastic UL94-V0
Degree of protection		IP20	IP20	IP20
Order Code		B7128	B7141	B7154
Order Code (With remote signaling)		B7129	B7142	B7155

BR-25GR 1+1 Type 1 Surge Arrester

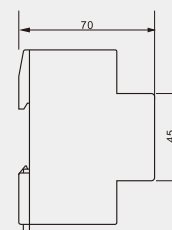
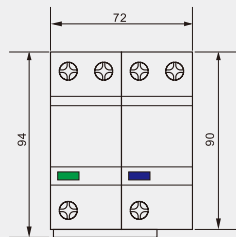
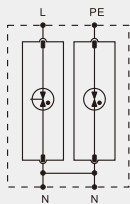
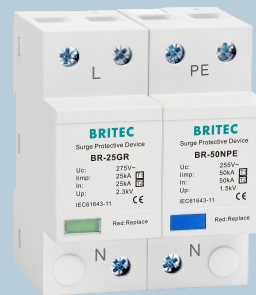

BR-25GR 1+1 surge arrester is suitable for TT and TN-S system.

		BR-25GR 150 1+1	BR-25GR 275 1+1	BR-25GR 320 1+1
SPD classification according to EN61643-11		Type 1 + Type 2	Type 1 + Type 2	Type 1 + Type 2
SPD classification according to IEC61643-11		Class I + Class II	Class I + Class II	Class I + Class II
Max. continuous operating a.c. voltage	U_c (L-N/N-PE)	150V/255V (50/60Hz)	275V/255V (50/60Hz)	320V/255V (50/60Hz)
Lightning impulse current (10/350 μ s)	I_{imp} (L-N/N-PE)	25kA/50kA	25kA/50kA	25kA/50kA
Nominal discharge current (8/20 μ s)	I_n (L-N/N-PE)	25kA/50kA	25kA/50kA	25kA/50kA
Maximum discharge current (8/20 μ s)	I_{max} (L-N/N-PE)	100kA/100kA	100kA/100kA	100kA/100kA
Quantity of electric charge (L-N,N-PE)	Q	12.5As, 25As	12.5As, 25As	12.5As, 25As
Specific energy (L-N,N-PE)	W/R	156kJ/ Ω , 625kJ/ Ω	156kJ/ Ω , 625kJ/ Ω	156kJ/ Ω , 625kJ/ Ω
Voltage protection level	U_p (L-N/N-PE)	$\leq 2.3kV/\leq 1.5kV$	$\leq 2.3kV/\leq 1.5kV$	$\leq 2.3kV/\leq 1.5kV$
Short-circuit current rating a.c.	I_{sccr} (L-N/N-PE)	25kA rms/100A rms	25kA rms/100A rms	25kA rms/100A rms
Max. backup fuse		315A gG	315A gG	315A gG
Temporary overvoltage	TOV (L-N)	440V/120min -withstand	440V/120min -withstand	440V/120min -withstand
Temporary overvoltage	TOV (N-PE)	1200V/200ms -withstand	1200V/200ms -withstand	1200V/200ms -withstand
Response time	t_A	$\leq 100ns$	$\leq 100ns$	$\leq 100ns$
Operating temperature range	T_u	-40°C-80°C	-40°C-80°C	-40°C-80°C
Cross-section area (Min.)		4mm ²	4mm ²	4mm ²
Cross-section area(Max.)		35mm ²	35mm ²	35mm ²
For mounting on		35mm Din rail	35mm Din rail	35mm Din rail
Enclosure material		Thermoplastic UL94-V0	Thermoplastic UL94-V0	Thermoplastic UL94-V0
Degree of protection		IP20	IP20	IP20
Order Code		B7130	B7143	B7156
Order Code (With remote signaling)		B7131	B7144	B7157

BR-25M 4P

Type 1+Type 2+Type 3
Surge Arrester

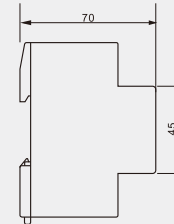
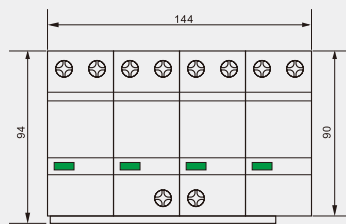
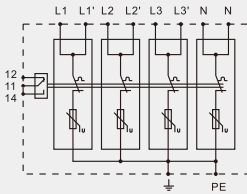

BR-25M 4P is suitable for TN-S system.

	BR-25M 150 4P	BR-25M 275 4P	BR-25M 320 4P
SPD classification according to EN61643-11	Type 1 + Type 2 + Type 3	Type 1 + Type 2 + Type 3	Type 1 + Type 2 + Type 3
SPD classification according to IEC61643-11	Class I + Class II + Class III	Class I + Class II + Class III	Class I + Class II + Class III
Max. continuous operating a.c. voltage	Uc	150V (50/60Hz)	275V (50/60Hz)
Lightning impulse current (10/350µs)	Iimp	25kA	25kA
Nominal discharge current (8/20µs)	In	25kA	25kA
Maximum discharge current (8/20µs)	I _{max}	120kA	120kA
Quantity of electric charge	Q	12.5As	12.5As
Specific energy	W/R	156kJ/Ω	156kJ/Ω
Voltage protection level	Up	≤0.8kV	≤1.3kV
Short-circuit current rating a.c.	I _{sc}	25kA rms	25kA rms
Max. backup fuse		315A gG	315A gG
Temporary overvoltage	TOV	175V/5s-withstand	335V/5s-withstand
Temporary overvoltage	TOV	250V/120min-safe failure	440V/120min-safe failure
Response time	t _a	≤25ns	≤25ns
Operating temperature range	T _u	-40°C-80°C	-40°C-80°C
Cross-section area (Min.)		4mm ²	4mm ²
Cross-section area(Max.)		35mm ²	35mm ²
For mounting on		35mm Din rail	35mm Din rail
Enclosure material		Thermoplastic UL94-V0	Thermoplastic UL94-V0
Degree of protection		IP20	IP20
Order Code		B7200	B7213
Order Code (With remote signaling)		B7201	B7214

BR-25M 3P

Type 1+Type 2+Type 3
Surge Arrester

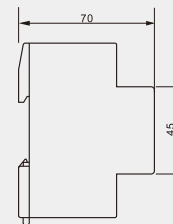
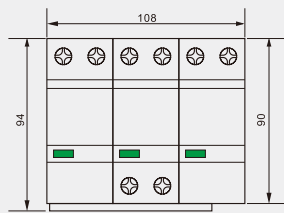
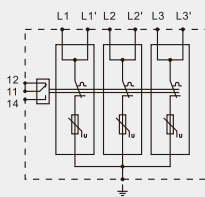

■ BR-25M 3P is suitable for TN-C system.

	BR-25M 150 3P	BR-25M 275 3P	BR-25M 320 3P
SPD classification according to EN61643-11	Type 1 + Type 2 + Type 3	Type 1 + Type 2 + Type 3	Type 1 + Type 2 + Type 3
SPD classification according to IEC61643-11	Class I + Class II + Class III	Class I + Class II + Class III	Class I + Class II + Class III
Max. continuous operating a.c. voltage	Uc	150V (50/60Hz)	275V (50/60Hz)
Lightning impulse current (10/350µs)	Iimp	25kA	25kA
Nominal discharge current (8/20µs)	In	25kA	25kA
Maximum discharge current (8/20µs)	I _{max}	120kA	120kA
Quantity of electric charge	Q	12.5As	12.5As
Specific energy	W/R	156kJ/Ω	156kJ/Ω
Voltage protection level	Up	≤0.8kV	≤1.3kV
Short-circuit current rating a.c.	I _{sc}	25kA rms	25kA rms
Max. backup fuse		315A gG	315A gG
Temporary overvoltage	TOV	175V/5s-withstand	335V/5s -withstand
Temporary overvoltage	TOV	250V/120min-safe failure	440V/120min-safe failure
Response time	t _a	≤25ns	≤25ns
Operating temperature range	T _u	-40°C-80°C	-40°C-80°C
Cross-section area (Min.)		4mm ²	4mm ²
Cross-section area(Max.)		35mm ²	35mm ²
For mounting on		35mm Din rail	35mm Din rail
Enclosure material		Thermoplastic UL94-V0	Thermoplastic UL94-V0
Degree of protection		IP20	IP20
Order Code		B7202	B7215
Order Code (With remote signaling)		B7203	B7216

BR-25M 2P

Type 1+Type 2+Type 3
Surge Arrester

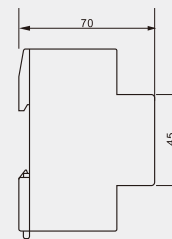
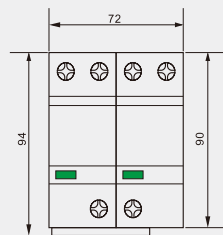
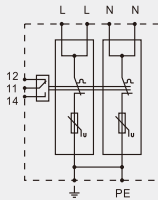

■ BR-25M 2P surge arrester is suitable for single phase TN system.

	BR-25M 150 2P	BR-25M 275 2P	BR-25M 320 2P
SPD classification according to EN61643-11	Type 1 + Type 2 + Type 3	Type 1 + Type 2 + Type 3	Type 1 + Type 2 + Type 3
SPD classification according to IEC61643-11	Class I + Class II + Class III	Class I + Class II + Class III	Class I + Class II + Class III
Max. continuous operating a.c. voltage	Uc	150V (50/60Hz)	275V (50/60Hz)
Lightning impulse current (10/350µs)	Iimp	25kA	25kA
Nominal discharge current (8/20µs)	In	25kA	25kA
Maximum discharge current (8/20µs)	I _{max}	120kA	120kA
Quantity of electric charge	Q	12.5As	12.5As
Specific energy	W/R	156kJ/Ω	156kJ/Ω
Voltage protection level	Up	≤ 0.8kV	≤ 1.3kV
Short-circuit current rating a.c.	I _{sc}	25kA rms	25kA rms
Max. backup fuse		315A gG	315A gG
Temporary overvoltage	TOV	175V/5s-withstand	335V/5s-withstand
Temporary overvoltage	TOV	250V/120min-safe failure	440V/120min-safe failure
Response time	t _A	≤ 25ns	≤ 25ns
Operating temperature range	T _u	-40°C-80°C	-40°C-80°C
Cross-section area (Min.)		4mm ²	4mm ²
Cross-section area(Max.)		35mm ²	35mm ²
For mounting on		35mm Din rail	35mm Din rail
Enclosure material		Thermoplastic UL94-V0	Thermoplastic UL94-V0
Degree of protection		IP20	IP20
Order Code		B7204	B7217
Order Code (With remote signaling)		B7205	B7218

BR-25M 1P

Type 1+Type 2+Type 3
Surge Arrester

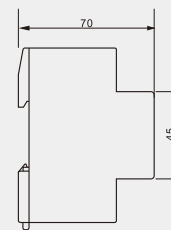
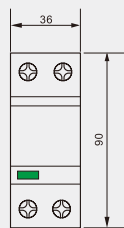
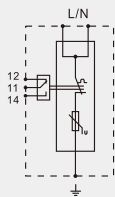

BR-25M 1P can be used to build 2P, 3P and 4P surge arresters.

	BR-25M 150 1P	BR-25M 275 1P	BR-25M 320 1P
SPD classification according to EN61643-11	Type 1 + Type 2 + Type 3	Type 1 + Type 2 + Type 3	Type 1 + Type 2 + Type 3
SPD classification according to IEC61643-11	Class I + Class II + Class III	Class I + Class II + Class III	Class I + Class II + Class III
Max. continuous operating a.c. voltage	Uc	150V (50/60Hz)	275V (50/60Hz)
Lightning impulse current (10/350µs)	Iimp	25kA	25kA
Nominal discharge current (8/20µs)	In	25kA	25kA
Maximum discharge current (8/20µs)	Imax	120kA	120kA
Quantity of electric charge	Q	12.5As	12.5As
Specific energy	W/R	156kJ/Ω	156kJ/Ω
Voltage protection level	Up	≤0.8kV	≤1.3kV
Short-circuit current rating a.c.	Isccr	25kA rms	25kA rms
Max. backup fuse		315A gG	315A gG
Temporary overvoltage	TOV	175V/5s-withstand	335V/5s -withstand
Temporary overvoltage	TOV	250V/120min-safe failure	440V/120min-safe failure
Response time	tA	≤25ns	≤25ns
Operating temperature range	Tu	-40°C-80°C	-40°C-80°C
Cross-section area (Min.)		4mm ²	4mm ²
Cross-section area(Max.)		35mm ²	35mm ²
For mounting on		35mm Din rail	35mm Din rail
Enclosure material		Thermoplastic UL94-V0	Thermoplastic UL94-V0
Degree of protection		IP20	IP20
Order Code		B7206	B7219
Order Code (With remote signaling)		B7207	B7220

BR-25M 3+1

Type 1+Type 2+Type 3
Surge Arrester

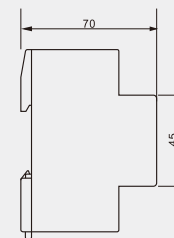
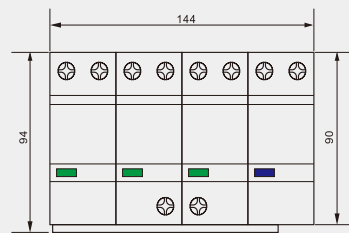
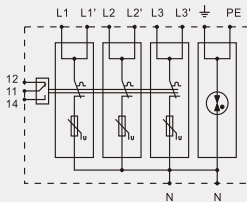

■ BR-25M 3+1 surge arrester is suitable for TT and TN-S system.

	BR-25M 150 3+1	BR-25M 275 3+1	BR-25M 320 3+1
SPD classification according to EN61643-11	Type 1 + Type 2 + Type 3	Type 1 + Type 2 + Type 3	Type 1 + Type 2 + Type 3
SPD classification according to IEC61643-11	Class I + Class II + Class III	Class I + Class II + Class III	Class I + Class II + Class III
Max. continuous operating a.c. voltage U_c (L-N/N-PE)	150V/255V (50/60Hz)	275V/255V (50/60Hz)	320V/255V (50/60Hz)
Lightning impulse current (10/350 μ s) I_{imp} (L-N/N-PE)	25kA/100kA	25kA/100kA	25kA/100kA
Nominal discharge current (8/20 μ s) I_n (L-N/N-PE)	25kA/100kA	25kA/100kA	25kA/100kA
Maximum discharge current (8/20 μ s) I_{max} (L-N/N-PE)	120kA/200kA	120kA/200kA	120kA/200kA
Quantity of electric charge (L-N,N-PE) Q	12.5As, 50As	12.5As, 50As	12.5As, 50As
Specific energy (L-N,N-PE) W/R	156kJ/ Ω , 2500kJ/ Ω	156kJ/ Ω , 2500kJ/ Ω	156kJ/ Ω , 2500kJ/ Ω
Voltage protection level U_p (L-N/N-PE)	$\leq 0.8kV/\leq 1.5kV$	$\leq 1.3kV/\leq 1.5kV$	$\leq 1.5kV/\leq 1.5kV$
Short-circuit current rating a.c. I_{scCR} (L-N/N-PE)	25kA rms/100A rms	25kA rms/100A rms	25kA rms/100A rms
Max. backup fuse	315A gG	315A gG	315A gG
Temporary overvoltage TOV (L-N)	175V/5s-withstand	335V/5s-withstand	350V/5s-withstand
Temporary overvoltage TOV (L-N)	250V/120min-safe failure	440V/120min-safe failure	550V/120min-safe failure
Temporary overvoltage TOV (N-PE)	1200V/200ms-withstand	1200V/200ms-withstand	1200V/200ms-withstand
Response time t_A	$\leq 25ns/\leq 100ns$	$\leq 25ns/\leq 100ns$	$\leq 25ns/\leq 100ns$
Operating temperature range T_u	-40°C-80°C	-40°C-80°C	-40°C-80°C
Cross-section area (Min.)	4mm ²	4mm ²	4mm ²
Cross-section area(Max.)	35mm ²	35mm ²	35mm ²
For mounting on	35mm Din rail	35mm Din rail	35mm Din rail
Enclosure material	Thermoplastic UL94-V0	Thermoplastic UL94-V0	Thermoplastic UL94-V0
Degree of protection	IP20	IP20	IP20
Order Code	B7208	B8163	B7221
Order Code (With remote signaling)	B7209	B8164	B7222

BR-25M 1+1

Type 1+Type 2+Type 3
Surge Arrester

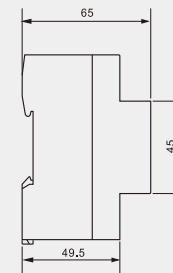
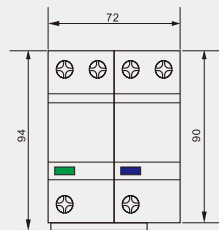
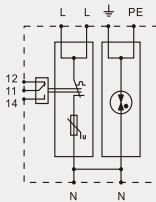

■ BR-25M 1+1 surge arrester is suitable for TT and TN-S system.

	BR-25M 150 1+1	BR-25M 275 1+1	BR-25M 320 1+1
SPD classification according to EN61643-11	Type 1 + Type 2 + Type 3	Type 1 + Type 2 + Type 3	Type 1 + Type 2 + Type 3
SPD classification according to IEC61643-11	Class I + Class II + Class III	Class I + Class II + Class III	Class I + Class II + Class III
Max. continuous operating a.c. voltage U_c (L-N/N-PE)	150V/255V (50/60Hz)	275V/255V (50/60Hz)	320V/255V (50/60Hz)
Lightning impulse current (10/350 μ s) I_{imp} (L-N/N-PE)	25kA/50kA	25kA/50kA	25kA/50kA
Nominal discharge current (8/20 μ s) I_n (L-N/N-PE)	25kA/50kA	25kA/50kA	25kA/50kA
Maximum discharge current (8/20 μ s) I_{max} (L-N/N-PE)	120kA/100kA	120kA/100kA	120kA/100kA
Quantity of electric charge (L-N,N-PE) Q	12.5As, 25As	12.5As, 25As	12.5As, 25As
Specific energy (L-N,N-PE) W/R	156kJ/ Ω , 625kJ/ Ω	156kJ/ Ω , 625kJ/ Ω	156kJ/ Ω , 625kJ/ Ω
Voltage protection level U_p (L-N/N-PE)	$\leq 0.8kV/\leq 1.5kV$	$\leq 1.3kV/\leq 1.5kV$	$\leq 1.5kV/\leq 1.5kV$
Short-circuit current rating a.c. I_{scCR} (L-N/N-PE)	25kA rms/100A rms	25kA rms/100A rms	25kA rms/100A rms
Max. backup fuse	315A gG	315A gG	315A gG
Temporary overvoltage TOV (L-N)	175V/5s-withstand	335V/5s -withstand	350V/5s-withstand
Temporary overvoltage TOV (L-N)	250V/120min-safe failure	440V/120min-safe failure	550V/120min-safe failure
Temporary overvoltage TOV (N-PE)	1200V/200ms -withstand	1200V/200ms -withstand	1200V/200ms -withstand
Response time t_A	$\leq 25ns/\leq 100ns$	$\leq 25ns/\leq 100ns$	$\leq 25ns/\leq 100ns$
Operating temperature range T_u	-40°C-80°C	-40°C-80°C	-40°C-80°C
Cross-section area (Min.)	4mm ²	4mm ²	4mm ²
Cross-section area(Max.)	35mm ²	35mm ²	35mm ²
For mounting on	35mm Din rail	35mm Din rail	35mm Din rail
Enclosure material	Thermoplastic UL94-V0	Thermoplastic UL94-V0	Thermoplastic UL94-V0
Degree of protection	IP20	IP20	IP20
Order Code	B7210	B8153	B7223
Order Code (With remote signaling)	B7211	B8154	B7224

BR-25GRS 3+1 Type 1 Surge Arrester

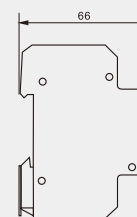
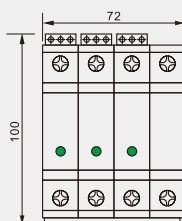
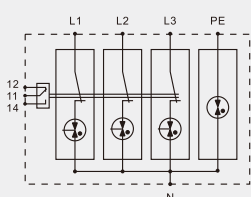

BR-25GRS 3+1 surge arrester is suitable for TT and TN-S system

		BR-25GRS 150 3+1	BR-25GRS 275 3+1	BR-25GRS 320 3+1
SPD classification according to EN61643-11		Type 1 + Type 2	Type 1 + Type 2	Type 1 + Type 2
SPD classification according to IEC61643-11		Class I + Class II	Class I + Class II	Class I + Class II
Max. continuous operating a.c. voltage	Uc (L-N/N-PE)	150V/255V (50/60Hz)	275V/255V (50/60Hz)	320V/255V (50/60Hz)
Lightning impulse current (10/350µs)	Iimp (L-N/N-PE)	25kA/100kA	25kA/100kA	25kA/100kA
Nominal discharge current (8/20µs)	In (L-N/N-PE)	25kA/100kA	25kA/100kA	25kA/100kA
Maximum discharge current (8/20µs)	I _{max} (L-N/N-PE)	50kA/160kA	50kA/160kA	50kA/160kA
Quantity of electric charge (L-N,N-PE)	Q	12.5As, 50As	12.5As, 50As	12.5As, 50As
Specific energy (L-N,N-PE)	W/R (L-N/N-PE)	156kJ/Ω, 2500kJ/Ω	156kJ/Ω, 2500kJ/Ω	156kJ/Ω, 2500kJ/Ω
Voltage protection level	Up (L-N/N-PE)	≤2.3kV/≤1.5kV	≤2.3kV/≤1.5kV	≤2.3kV/≤1.5kV
Short-circuit current rating a.c.	I _{SCCR} (L-N/N-PE)	25kA rms/100A rms	25kA rms/100A rms	25kA rms/100A rms
Max. backup fuse		250A gG	250A gG	250A gG
Temporary overvoltage	TOV (L-N)	440V/120min -withstand	440V/120min -withstand	440V/120min -withstand
Temporary overvoltage	TOV (N-PE)	1200V/200ms -withstand	1200V/200ms -withstand	1200V/200ms -withstand
Response time	t _A	≤100ns	≤100ns	≤100ns
Operating temperature range	T _u	-40°C-80°C	-40°C-80°C	-40°C-80°C
Cross-section area (Min.)		4mm ²	4mm ²	4mm ²
Cross-section area (Max.)		35mm ²	35mm ²	35mm ²
For mounting on		35mm Din rail	35mm Din rail	35mm Din rail
Enclosure material		Thermoplastic UL94-V0	Thermoplastic UL94-V0	Thermoplastic UL94-V0
Degree of protection		IP20	IP20	IP20
Order Code		B7058	B7071	B7084
Order Code (With remote signaling)		B7059	B7072	B7085

BR-25GRS 1+1 Type 1 Surge Arrester

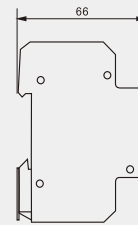
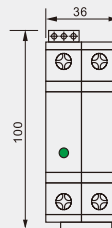
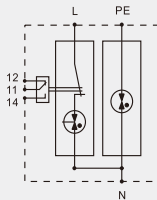

■ BR-25GRS 1+1 surge arrester is suitable for TT and TN-S system

		BR-25GRS 150 1+1	BR-25GRS 275 1+1	BR-25GRS 320 1+1
SPD classification according to EN61643-11		Type 1 + Type 2	Type 1 + Type 2	Type 1 + Type 2
SPD classification according to IEC61643-11		Class I + Class II	Class I + Class II	Class I + Class II
Max. continuous operating a.c. voltage	Uc (L-N/N-PE)	150V/255V (50/60Hz)	275V/255V (50/60Hz)	320V/255V (50/60Hz)
Lightning impulse current (10/350µs)	Iimp (L-N/N-PE)	25kA/50kA	25kA/50kA	25kA/50kA
Nominal discharge current (8/20µs)	In (L-N/N-PE)	25kA/50kA	25kA/50kA	25kA/50kA
Maximum discharge current (8/20µs)	I _{max} (L-N/N-PE)	50kA/100kA	50kA/100kA	50kA/100kA
Quantity of electric charge (L-N,N-PE)	Q	12.5As, 25As	12.5As, 25As	12.5As, 25As
Specific energy (L-N,N-PE)	W/R (L-N/N-PE)	156kJ/Ω, 625kJ/Ω	156kJ/Ω, 625kJ/Ω	156kJ/Ω, 625kJ/Ω
Voltage protection level	Up (L-N/N-PE)	≤2.3kV/≤1.5kV	≤2.3kV/≤1.5kV	≤2.3kV/≤1.5kV
Short-circuit current rating a.c.	I _{sc} (L-N/N-PE)	25kA rms/100A rms	25kA rms/100A rms	25kA rms/100A rms
Max. backup fuse		250A gG	250A gG	250A gG
Temporary overvoltage	TOV (L-N)	440V/120min -withstand	440V/120min -withstand	440V/120min -withstand
Temporary overvoltage	TOV (N-PE)	1200V/200ms -withstand	1200V/200ms -withstand	1200V/200ms -withstand
Response time	t _A	≤100ns	≤100ns	≤100ns
Operating temperature range	T _u	-40°C-80°C	-40°C-80°C	-40°C-80°C
Cross-section area (Min.)		4mm ²	4mm ²	4mm ²
Cross-section area (Max.)		35mm ²	35mm ²	35mm ²
For mounting on		35mm Din rail	35mm Din rail	35mm Din rail
Enclosure material		Thermoplastic UL94-V0	Thermoplastic UL94-V0	Thermoplastic UL94-V0
Degree of protection		IP20	IP20	IP20
Order Code		B7060	B7073	B7086
Order Code (With remote signaling)		B7061	B7074	B7087

www.britecelectric.com



BRITEC

Britec Electric Co., Ltd.

Add: Jing 9 Road, Wei 10 cross, Yueqing Economic Development Zone,
Yueqing, Zhejiang, China

Tel: +86-577-6260 5321

Fax: +86-577-6260 5320

E-mail: britec@britecelectric.com

Website: www.britecelectric.com